

BUFFET

BUFFET

DOMINO





Alzata presentazione corten Domino

Domino podium, corten
 Présentoir Domino corten
 Domino Podium, corton
 Soporte presentación Domino corten

Acciaio Verniciato - Varnished Steel

	cm	H. cm	in	H. in
V331842020	20x40	9	7,7/8x15,3/4	3,1/2



Alzata presentazione corten Domino

Domino podium, corten
 Présentoir Domino corten
 Domino Podium, corton
 Soporte presentación Domino corten

Acciaio Verniciato - Varnished Steel

	cm	H. cm	in	H. in
V331842021	20x40	20	7,7/8x15,3/4	7,7/8



Alzata presentazione corten Domino

Domino podium, corten
 Présentoir Domino corten
 Domino Podium, corton
 Soporte presentación Domino corten

Acciaio Verniciato - Varnished Steel

	cm	H. cm	in	H. in
V331842022	20x60	9	7,7/8x23,5/8	3,1/2

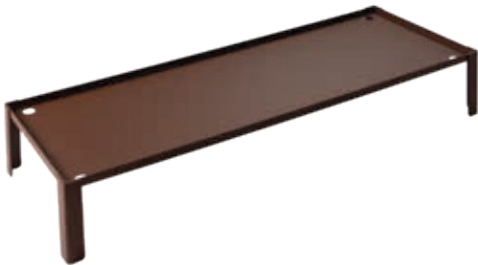

Alzata presentazione corten Domino

Domino podium, corten
 Présentoir Domino corten
 Domino Podium, corton
 Soporte presentación Domino corten

Acciaio Verniciato - Varnished Steel

	cm	H. cm	in	H. in
V331842023	20x60	20	7,7/8x23,5/8	7,7/8



Alzata presentazione corten Domino

Domino podium, corten
 Présentoir Domino corten
 Domino Podium, corton
 Soporte presentación Domino corten

Acciaio Verniciato - Varnished Steel

	cm	H. cm	in	H. in
V331842024	40x40	9	15,3/4x15,3/4	3,1/2



Alzata presentazione corten Domino

Domino podium, corten
 Présentoir Domino corten
 Domino Podium, corton
 Soporte presentación Domino corten

Acciaio Verniciato - Varnished Steel

	cm	H. cm	in	H. in
V331842025	40x60	9	15,3/4x23,5/8	7,7/8





Alzata presentazione nera Domino

Domino podium, black
 Présentoir Domino noir
 Domino Podium, schwarz
 Soporte presentación Domino negro

Acciaio Verniciato - Varnished Steel

	cm	H. cm	in	H. in
V331842010	20x40	9	7,7/8x15,3/4	3,1/2



Alzata presentazione nera Domino

Domino podium, black
 Présentoir Domino noir
 Domino Podium, schwarz
 Soporte presentación Domino negro

Acciaio Verniciato - Varnished Steel

	cm	H. cm	in	H. in
V331842011	20x40	20	7,7/8x15,3/4	7,7/8



Alzata presentazione nera Domino

Domino podium, black
 Présentoir Domino noir
 Domino Podium, schwarz
 Soporte presentación Domino negro

Acciaio Verniciato - Varnished Steel

	cm	H. cm	in	H. in
V331842012	20x60	9	7,7/8x23,5/8	3,1/2



Alzata presentazione nera Domino

Domino podium, black
 Présentoir Domino noir
 Domino Podium, schwarz
 Soporte presentación Domino negro

Acciaio Verniciato - Varnished Steel

	cm	H. cm	in	H. in
V331842013	20x60	20	7,7/8x23,5/8	7,7/8



Alzata presentazione nera Domino

Domino podium, black
 Présentoir Domino noir
 Domino Podium, schwarz
 Soporte presentación Domino negro

Acciaio Verniciato - Varnished Steel

	cm	H. cm	in	H. in
V331842014	40x40	9	15,3/4x15,3/4	3,1/2



Alzata presentazione nera Domino

Domino podium, black
 Présentoir Domino noir
 Domino Podium, schwarz
 Soporte presentación Domino negro

Acciaio Verniciato - Varnished Steel

	cm	H. cm	in	H. in
V331842015	40x60	9	15,3/4x23,5/8	7,7/8





Alzata presentazione bianca Domino

Domino podium, white
 Présentoir Domino blanc
 Domino Podium, weiß
 Soporte presentación Domino blanco

Acciaio Verniciato - Varnished Steel

	cm	H. cm	in	H. in
V331842030	20x40	9	7,7/8x15,3/4	3,1/2

**Alzata presentazione bianca Domino**

Domino podium, white
 Présentoir Domino blanc
 Domino Podium, weiß
 Soporte presentación Domino blanco

Acciaio Verniciato - Varnished Steel

	cm	H. cm	in	H. in
V331842031	20x40	20	7,7/8x15,3/4	7,7/8

**Alzata presentazione bianca Domino**

Domino podium, white
 Présentoir Domino blanc
 Domino Podium, weiß
 Soporte presentación Domino blanco

Acciaio Verniciato - Varnished Steel

	cm	H. cm	in	H. in
V331842032	20x60	9	7,7/8x23,5/8	3,1/2

**Alzata presentazione bianca Domino**

Domino podium, white
 Présentoir Domino blanc
 Domino Podium, weiß
 Soporte presentación Domino blanco

Acciaio Verniciato - Varnished Steel

	cm	H. cm	in	H. in
V331842033	20x60	20	7,7/8x23,5/8	7,7/8

**Alzata presentazione bianca Domino**

Domino podium, white
 Présentoir Domino blanc
 Domino Podium, weiß
 Soporte presentación Domino blanco

Acciaio Verniciato - Varnished Steel

	cm	H. cm	in	H. in
V331842034	40x40	9	15,3/4x15,3/4	3,1/2

**Alzata presentazione bianca Domino**

Domino podium, white
 Présentoir Domino blanc
 Domino Podium, weiß
 Soporte presentación Domino blanco

Acciaio Verniciato - Varnished Steel

	cm	H. cm	in	H. in
V331842035	40x60	9	15,3/4x23,5/8	7,7/8





Gres Blue mix

	cm	in
V332142003	20x20	7,7/8x7,7/8



Gres Yellow mix

	cm	in
V332142006	20x20	7,7/8x7,7/8



Gres Light Grey

	cm	in
V332142004	20x20	7,7/8x7,7/8



Gres Dark Grey

	cm	in
V332142005	20x20	7,7/8x7,7/8



Gres Grey mix

	cm	in
V332142001	20x20	7,7/8x7,7/8

**Gres Corten mix**

	cm	in
V332142002	20x20	7,7/8x7,7/8

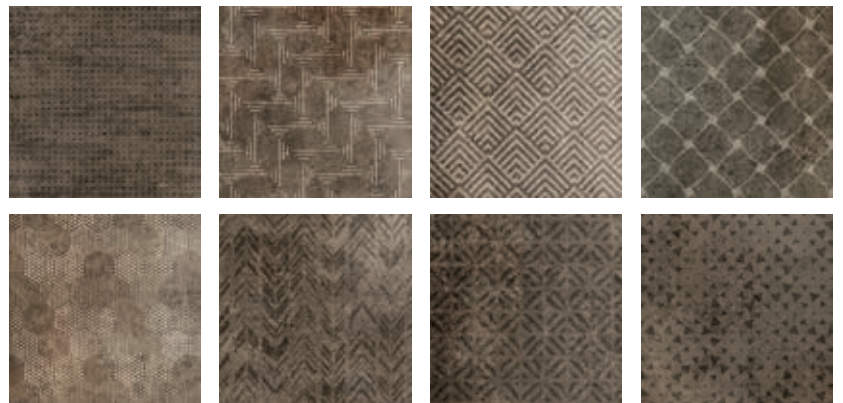
**Piatto acciaio Domino**

Domino plate, steel
Plat en acier Domino
Domino, Edelstahlplatte
Plato acero Domino

Inox 18/10 - St.Steel

	cm	in
Z332842001	40x20	15,3/4x7,7/8

**Piatto acciaio Domino**

Domino plate, steel
Plat en acier Domino
Domino, Edelstahlplatte
Plato acero Domino

Inox 18/10 - St.Steel

	cm	in
Z332842002	60x20	23,5/8x7,7/8



DOMINO





Cornice bianca Domino

Domino frame, white
 Cadre blanc Domino
 Domino Rahmen, weiß
 Marco blanco Domino

Legno Massello - Solid Wood

	cm	H. cm	in	H. in
V330442131	20x40	5	7,7/8x15,3/4	2

**Cornice bianca Domino**

Domino frame, white
 Cadre blanc Domino
 Domino Rahmen, weiß
 Marco blanco Domino

Legno Massello - Solid Wood

	cm	H. cm	in	H. in
V330442132	20x60	5	7,7/8x23,5/8	2

**Cornice bianca Domino**

Domino frame, white
 Cadre blanc Domino
 Domino Rahmen, weiß
 Marco blanco Domino

Legno Massello - Solid Wood

	cm	H. cm	in	H. in
V330442133	40x40	5	15,3/4x15,3/4	2

**Cornice bianca Domino**

Domino frame, white
 Cadre blanc Domino
 Domino Rahmen, weiß
 Marco blanco Domino

Legno Massello - Solid Wood

	cm	H. cm	in	H. in
V330442134	40x60	5	15,3/4x23,5/8	2





Cornice scura Domino

Domino frame, dark
 Cadre foncé Domino
 Domino Rahmen, dunkel
 Marco oscuro Domino

Legno Massello - Solid Wood

	cm	H. cm	in	H. in
V330442151	20x40	5	7,7/8x15,3/4	2

**Cornice scura Domino**

Domino frame, dark
 Cadre foncé Domino
 Domino Rahmen, dunkel
 Marco oscuro Domino

Legno Massello - Solid Wood

	cm	H. cm	in	H. in
V330442152	20x60	5	7,7/8x23,5/8	2

**Cornice scura Domino**

Domino frame, dark
 Cadre foncé Domino
 Domino Rahmen, dunkel
 Marco oscuro Domino

Legno Massello - Solid Wood

	cm	H. cm	in	H. in
V330442153	40x40	5	15,3/4x15,3/4	2

**Cornice scura Domino**

Domino frame, dark
 Cadre foncé Domino
 Domino Rahmen, dunkel
 Marco oscuro Domino

Legno Massello - Solid Wood

	cm	H. cm	in	H. in
V330442154	40x60	5	15,3/4x23,5/8	2







Griglia 3 caraffe Domino

Domino stand, 3-pitcher
Support pour 3 carafes Domino
Domino, Halterung für 3 Flaschen
Soporte para 3 jarras Domino

Acciaio 18/10 - St. Steel

	cm	in
Z334742001	40x20	15,3/4x7,7/8

Eutettico rettangolare

Ice pack
Bloc réfrigérant
Kühlakkus
Acumulador de frío rectangular

	cm	H. cm	in	H. in
V771295M00	17x8	2	6,3/4x3,1/8	0,3/4

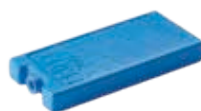

Piatto acciaio Domino

Domino plate, steel
 Plat en acier Domino
 Domino, Edelstahlplatte
 Plato acero Domino

Acciaio 18/10 - St. Steel

	cm	in
Z332842001	40x20	15,3/4x7,7/8

**Piatto acciaio Domino**

Domino plate, steel
 Plat en acier Domino
 Domino, Edelstahlplatte
 Plato acero Domino

Acciaio 18/10 - St. Steel

	cm	in
Z332842002	60x20	23,5/8x7,7/8

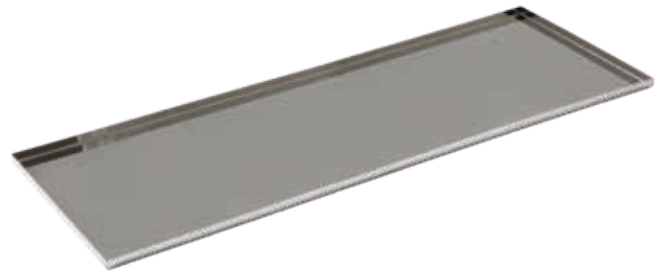
**Copri eutettico Domino**

Domino ice-pack cover
 Couvercle bloc réfrigérant Domino
 Domino, Abdeckung Kühlpacks
 Tapa para acumulador de frío Domino

Acciaio 18/10 - St. Steel

	cm	in
Z331942001	36x16	14,1/8x6,1/4

**Copri eutettico Domino**

Domino ice-pack cover
 Couvercle bloc réfrigérant Domino
 Domino, Abdeckung Kühlpacks
 Tapa para acumulador de frío Domino

Acciaio 18/10 - St. Steel

	cm	in
Z331942002	56x16	22x6,1/4

**Bacinella porta eutettici/briciole Domino**

Domino ice-pack/crumb holder
 Cuvette blocs réfrigérants/miettes Domino
 Domino, Kühlpack- Krümelhalter
 Cubeta para acumuladores de frío/migas Domino

Alluminio - Aluminum

	cm	in
Z332042001	40x16	15,3/4x6,1/4

**Bacinella porta eutettici/briciole Domino**

Domino ice-pack/crumb holder
 Cuvette blocs réfrigérants/miettes Domino
 Domino, Kühlpack- Krümelhalter
 Cubeta para acumuladores de frío/migas Domino

Alluminio - Aluminum

	cm	in
Z332042002	60x16	23,5/8x6,1/4



Base per barattolo bianca Domino

Domino base for jar, white
 Base pour pot blanc Domino
 Domino Basis für Krug, weiß
 Base para bote blanco Domino

Legno Massello - Solid Wood

	cm	H. cm	in	H. in
V330442135	20x20	1,5	7,7/8x7,7/8	0,5/8

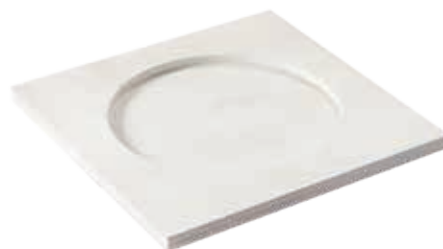
**Base per barattolo scura Domino**

Domino base for jar, dark
 Base pour pot foncé Domino
 Domino Basis für Krug, dunkel
 Base para bote oscuro Domino

Legno Massello - Solid Wood

	cm	H. cm	in	H. in
V330442155	20x20	1,5	7,7/8x7,7/8	0,5/8

**Base per bicchieri bianca Domino**

Domino base for glasses, white
 Base pour verres blanc
 Domino Basis für Weißweingläser, weiß
 Base para vasos blanco Domino

Legno Massello - Solid Wood

	cm	H. cm	in	H. in
V330442136	20x20	1,5	7,7/8x7,7/8	0,5/8

**Base per bicchieri scura Domino**

Domino base for glasses, dark
 Base pour verres foncé Domino
 Domino Basis für Weißweingläser, dunkel
 Base para vasos oscuro Domino

Legno Massello - Solid Wood

	cm	H. cm	in	H. in
V330442156	20x20	1,5	7,7/8x7,7/8	0,5/8



Vaso in vetro con coperchio

Glass jar with lid
 Pot en verre avec couvercle
 Jarrón de vidrio con tapa
 Glasdose mit Deckel

Vetro - Glass

	Ø cm	Ø in	H. cm	H. in
4041031304	14	5,1/2	17,5	6,7/8
4041031305	14	5,1/2	23	9
4041031306	14	5,1/2	29,5	11,5/8

**Bicchiere vetro basso**

Glass glass, small
 Verre bas en verre
 Glass, klein
 Vaso cristal bajo

Vetro - Glass

	Ø cm	H. cm	lt	Ø in	H. in	oz
V860842BBA	6	8	0,10	2,3/8	3,1/8	3,5

**Ciotola quadra porcellana**

Porcelain bowl
 Bol carré en porcelaine
 Porzellanschale, viereckig
 Bol cuadrado de porcellana

Porcellana - Porcelain

	cm	H. cm	in	H. in
V862142CQ7	7x7	3,5	2,3/4x2,3/4	1,3/8



Tagliere color noce Domino

Domino cutting board, walnut colour
 Planche à découper couleur noix Domino
 Domino Schneidebrett, Walnuss
 Tabla de cortar color nuez Domino

Legno massello - Solid wood

	cm	H. cm	in	H. in
V330471002	40x40	2	15,3/4x15,3/4	0,3/4

**Tagliere color noce Domino**

Domino cutting board, walnut colour
 Planche à découper couleur noix Domino
 Domino Schneidebrett, Walnuss
 Tabla de cortar color nuez Domino

Legno massello - Solid wood

	cm	H. cm	in	H. in
V330471001	20x40	2	7,7/8x15,3/4	0,3/4

**Bacinella porta eutettici/briciole Domino**

Domino ice-pack/crumb holder
 Cuvette blocs réfrigérants/miettes Domino
 Domino, Kühlpack- Krümelhalter
 Cubeta para acumuladores de frío/migas Domino

Alluminio - Aluminium

	cm	in
Z332042001	40x16	15,3/4x6,1/4

**Bacinella porta eutettici/briciole Domino**

Domino ice-pack/crumb holder
 Cuvette blocs réfrigérants/miettes Domino
 Domino, Kühlpack- Krümelhalter
 Cubeta para acumuladores de frío/migas Domino

Alluminio - Aluminium

	cm	in
Z332042002	60x16	23,5/8x6,1/4



Tagliere formaggi color noce Domino

Domino cheese cutting board, walnut colour
 Planche à découper fromages couleur noix Domino
 Domino Käsebrett, Walnuss
 Tabla de cortar quesos color nuez Domino

Legno massello - Solid wood

	cm	H. cm	in	H. in
V330471003	20x40	2	7,7/8x15,3/4	0,3/4

**Tagliere formaggi con bascula color noce Domino**

Domino cheese cutting board with rolltop cover, walnut colour
 Planche à découper fromages avec cloche couleur noix Domino
 Domino Käsebrett schwenkdeckel, Walnuss
 Tabla cortar quesos tapa rolltop color nuez Domino

Legno massello - Solid Wood / SAN

	cm	H. cm	in	H. in
V330471004	20x40	16	7,7/8x15,3/4	6,1/4

**Coltello panettone manico vuoto Lux**

Lux Panettone knife hollow handle
 Couteau panettone manche vide Lux
 Lux Panettone-Messer mit hohlem Griff
 Cuchillo panettone mango hueco Lux

Acciaio Inox - St. Steel

	cm	in
9030591MV1	28,5	11,1/4



Guarda il video
 Watch the video



Vaso in vetro con coperchio

Glass jar with lid

Pot en verre avec couvercle

Jarrón de vidrio con tapa

Glasdose mit Deckel

Vetro - Glass

	ø cm	H. cm	ø in	H. in
4041031304	14	17,5	5,1/2	6,7/8

**Base per barattolo scura Domino**

Domino base for jar, dark

Base pour pot foncé Domino

Domino Basis für Krug, dunkel

Base para bote oscuro Domino

Legno Massello - Solid Wood

	cm	H. cm	in	H. in
V330442155	20x20	1,5	7,7/8x7,7/8	0,5/8

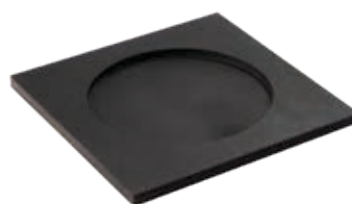

Cornice scura Domino

Domino frame, dark
Cadre foncé Domino
Domino Rahmen, dunkel
Marco oscuro Domino

Legno Massello - Solid Wood

	cm	H. cm	in	H. in
V330442152	20x60	5	7,7/8x23,5/8	2





Caraffa acqua con coperchio basculante

Water glass pitcher with smart lid

Carafe en verre avec couvercle basculant

Wasserkaraffe

Jarra de vidrio con tapa basculante

Vetro - Glass

	lt	oz
● V760852007	1	35
● V76085200735	1	35
● V76085200707	1	35



Cornice scura Domino

Domino frame, dark
Cadre foncé Domino
Domino Rahmen, dunkel
Marco oscuro Domino

Legno Massello - Solid Wood

	cm	H. cm	in	H. in
V330442152	20x60	5	7,7/8x23,5/8	2

**Bacinella porta eutettici/briciole Domino**

Domino ice-pack/crumb holder
Cuvette blocs réfrigérants/miettes Domino
Domino, Kühlpack- Krümelhalter
Cubeta para acumuladores de frío/migas Domino

Alluminio - Aluminum

	cm	in
Z332042002	60x16	23,5/8x6,1/4

**Eutettico rettangolare**

Ice pack
Bloc réfrigérant
Kühlakkus
Acumulador de frío rectangular

	cm	H. cm	in	H. in
V771295M00	17x8	2	6,3/4x3,1/8	0,3/4

**Copri eutettico Domino**

Domino ice-pack cover
Couvercle bloc réfrigérant Domino
Domino, Abdeckung Kühlpacks
Tapa para acumulador de frío Domino

Acciaio 18/10 - St. Steel

	cm	in
Z331942002	56x16	22x6,1/4

**Griglia 3 caraffe Domino**

Domino stand, 3-pitcher
Support pour 3 carafes Domino
Domino, Halterung für 3 Flaschen
Soporte para 3 jarras Domino

Acciaio 18/10 - St. Steel

	cm	in
Z334742001	40x20	15,3/4x7,7/8

**Gres Corten mix**

	cm	in
V332142002	20x20	7,7/8x7,7/8



Cornice scura Domino

Domino frame, dark
 Cadre foncé Domino
 Domino Rahmen, dunkel
 Marco oscuro Domino

Legno Massello - Solid Wood

	cm	H. cm	in	H. in
V330442152	20x60	5	7,7/8x23,5/8	2

**Bacinella porta eutettici/briciole Domino**

Domino ice-pack/crumb holder
 Cuvette blocs réfrigérants/miettes Domino
 Domino, Kühlpack- Krümelhalter
 Cubeta para acumuladores de frío/migas Domino

Alluminio - Aluminum

	cm	in
Z332042002	60x16	23,5/8x6,1/4



Tagliere color noce Domino

Domino cutting board, walnut colour
 Planche à découper couleur noix Domino
 Domino Schneidebrett, Walnuss
 Tabla de cortar color nuez Domino

Legno massello - Solid wood

	cm	H. cm	in	H. in
V330471001	20x40	2	7,7/8x15,3/4	0,3/4

**Gres Corten mix**

	cm	in
V332142002	20x20	7,7/8x7,7/8



Set pane bianco Domino

Domino bread set white
 Set à pain Domino blanc
 Domino, Brot Set; weiß
 Set pan Domino blanco

V3332SE002



Set refrigerato bianco Domino

Domino thermal set, white
 Set réfrigéré Domino blanc
 Domino, Thermo Set; weiß
 Set refrigerado Domino blanco

V3332SE006



Set cereali bianco Domino

Domino cereal set, white
 Set à céréales Domino blanc
 Domino, Cerealien Set; weiß
 Set cereales Domino blanco

V3332SE004



*Per l'acquisto, far riferimento alle fotografie dei set Domino bianco.

*For purchase, please, refer to the photos of Domino white sets.

*Pour l'achat, reportez-vous aux photos des sets Domino blanc.

*Informationen zum Kauf finden Sie auf den Fotos der Domino-Sets weiß.

*Para comprar, consulten las fotos de los sets Domino blanco.

Set pane scuro Domino

Domino bread set, dark
 Set à pain foncé Domino
 Domino, Brot Set; dunkel
 Set pan oscuro Domino

V3332SE001

**Set refrigerato scuro Domino**

Domino thermal set, dark
 Set réfrigéré foncé Domino
 Domino, Thermo Set; dunkel
 Set refrigerado oscuro Domino

V3332SE005

**Set cereali scuro Domino**

Domino cereal set, dark
 Set à céréales foncé Domino
 Domino, Cerealien Set; dunkel
 Set cereales oscuro Domino

V3332SE003



COSMO





Crostatina
di
Ciocco
Guanaja

Distributore caffè Cosmo

Cosmo coffee urn

Distributeur de café Cosmo

Cosmo, Kaffeespender

Dispensador de café Cosmo

	lt	H. cm	H. in
V333252002	7	44	17,3/8
V333252003	10	51	20,1/8

**Distributore succhi Cosmo**

Cosmo juice dispenser

Distributeur de jus Cosmo

Cosmo, Saftspender

Dispensador de zumos Cosmo

	lt	H. cm	H. in
V333252001	8	56	22

**Base salvagoccia con griglia Cosmo**

Cosmo drip-tray with grill

Base anti-gouttes avec grille Cosmo

Cosmo, Tropfschale mit Grill

Base salvagotas con rejilla Cosmo

con calamita - with magnet*Acciaio 18/10 - St. Steel**

	cm	in
Z339952001	16x16	6,1/4x6,1/4



Distributore cereali singolo Cosmo

Cosmo individual cereal dispenser
 Distributeur à cereales individuel Cosmo
 Cosmo, Cerealienspender
 Dispensador cereales individual Cosmo

	lt	H. cm	H. in
V333252015	3	53	20,7/8

**Distributore cereali doppio Cosmo**

Cosmo double cereal dispenser
 Distributeur à cereales double Cosmo
 Cosmo, Doppel-Cerealienspender
 Dispensador cereales doble Cosmo

	lt	H. cm	H. in
V333252016	3 (x2)	53	20,7/8



Alzata torta senza coperchio Cosmo

Cosmo cake stand without cover
 Présentoir à gâteau sans cloche Cosmo
 Cosmo, Kuchenständer ohne Haube
 Presentación tarta sin tapa Cosmo

Acciaio 18/10 - St. Steel / Legno massello - Solid wood

	∅ cm	H. cm	∅ in	H. in
V333242001	38	12	15	4,3/4

**Alzata torta senza coperchio Cosmo**

Cosmo cake stand without cover
 Présentoir à gâteau sans cloche Cosmo
 Cosmo, Kuchenständer ohne Haube
 Presentación tarta sin tapa Cosmo

Acciaio 18/10 - St. Steel / Legno massello - Solid wood

	∅ cm	H. cm	∅ in	H. in
V333242002	38	17	15	6,3/4



Alzata torta con coperchio Cosmo

Cosmo cake stand with cover

Présentoir à gâteau avec cloche Cosmo

Cosmo, Kuchenständer mit Haube

Presentación tarta con tapa Cosmo

Acciaio 18/10 - St. Steel / Legno massello - Solid wood / SAN

	ø cm	H. cm	ø in	H. in
V333242010	38	31	15	12,1/4

**Alzata torta con coperchio Cosmo**

Cosmo cake stand with cover

Présentoir à gâteau avec cloche Cosmo

Cosmo, Kuchenständer mit Haube

Presentación tarta con tapa Cosmo

Acciaio 18/10 - St. Steel / Legno massello - Solid wood / SAN

	ø cm	H. cm	ø in	H. in
V333242011	38	36	15	14,1/8



Portaformaggi /affettati refrigerato rettangolare con coperchio Cosmo

Cosmo thermal cheese/cold cuts tray rectangular
 Plateau fromage/charc réfrigéré rectangulaire avec cloche Cosmo
 Cosmo, Käseplatte mit Haube, gekühlt, rechteckig
 Portaquesos/embutidos refrigerado rectangular con tapa Cosmo

Acciaio 18/10 - St. Steel / Acciaio Verniciato - Varnished steel / SAN

	cm	H. cm	in	H. in	colore / colour
V333254005	29x48	21	11,3/8x18,7/8	8,1/4	nero / black
V333254006	29x48	21	11,3/8x18,7/8	8,1/4	corten



Piatto rettangolare refrigerato Cosmo

Cosmo plate, thermal, rectangular
 Plat rectangulaire réfrigéré Cosmo
 Cosmo, Platte rechteckig, gekühlt
 Plato rectangular refrigerado Cosmo

Acciaio 18/10 - St. Steel / Acciaio Verniciato - Varnished steel

	cm	H. cm	in	H. in	colore / colour
V333254015	29x48	5,5	11,3/8x18,7/8	2,1/8	nero / black
V333254016	29x48	5,5	11,3/8x18,7/8	2,1/8	corten



Alzata per piatti refrigerati rettangolari Cosmo

Cosmo stand for rectangular refrigerated plates
 Support à assiettes rectangulaires réfrigérées Cosmo
 Cosmo Ständer für gekühlte, rechteckige Platten
 Soporte rectangular Cosmo para platos refrigerados

Acciaio Verniciato - Varnished Steel

	cm	H. cm	in	H. in	colore / colour
V331854001	44x25	17	17,3/8x9,7/8	6,3/4	nero / black
V331854002	44x25	17	17,3/8x9,7/8	6,3/4	corten



Portaformaggi /affettati refrigerato tondo con coperchio Cosmo

Cosmo thermal cheese/cold cuts tray round
Plateau fromage/charc réfrigéré rond avec cloche Cosmo
Cosmo, Käseplatte mit Haube, gekühlt, rund
Portaquesos/embutidos refrigerado redondo con tapa Cosmo

Acciaio 18/10 - St. Steel / Acciaio Verniciato - Varnished steel / SAN

	ø cm	H. cm	ø in	H. in	colore / colour
V333254001	43	29	16,7/8	11,3/8	nero / black
V333254002	43	29	16,7/8	11,3/8	corten



Piatto tondo refrigerato Cosmo

Cosmo plate, thermal, round
Plat rond réfrigéré Cosmo
Cosmo, Platte rund, gekühlt
Plato redondo refrigerado Cosmo

Acciaio 18/10 - St. Steel / Acciaio Verniciato - Varnished steel

	ø cm	H. cm	ø in	H. in	colore / colour
V333254011	43	5,5	16,7/8	2,1/8	nero / black
V333254012	43	5,5	16,7/8	2,1/8	corten



Alzata buffet Cosmo

Cosmo buffet stand
Support à buffet Cosmo
Cosmo Buffetständer
Soporte buffet Cosmo

Acciaio Verniciato - Varnished Steel

	H. cm	H. in
V331842001	20	7,7/8
V331842002	25	9,7/8
V331842003	30	11,3/4

**Fornelletto per bistecchiera Cosmo**

Burner for Cosmo grill pan
Réchaud pour grill Cosmo
Réchaud für Grillpfanne Cosmo
Hornillo para parrilla Cosmo

Acciaio 18/10 - St. Steel / Acciaio Verniciato - Varnished steel

	H. cm	H. in
V333252010	21	8,1/4

**Ciotola/bastardella**

Bowl
Bol
Schüssel
Bol

Inox 18/10 - St. Steel

	ø cm	ø in
AVARI050	20	7,7/8
AVARI053	23	9
AVARI051	26	10,1/4
AVARI054	29	11,3/8

**Base tonda nero opaco**

Base, round, matte black
Base ronde noir mat
Basis, rund, matt schwarz
Base redonda negro mate

Legno Massello - Solid Wood

	ø cm	ø in
Z331952001	18,7	7,1/4





Cestino pane tondo con bascula Cosmo

Cosmo bread basket with rolltop cover, round
 Corbeille à pain rond avec cloche bascul Cosmo
 Cosmo, Brotkorb rund mit Rollhaube
 Cesta pan redonda con tapa roll-top Cosmo

Acciaio Verniciato - Varnished Steel / Juta / SAN

	ø cm	H. cm	ø in	H. in
V333224010	36	35	14,1/8	13,3/4



Cestino pane rettangolare con bascula Cosmo

Cosmo bread basket with rolltop cover, rectangular
 Corbeille à pain rectangulaire avec cloche bascul Cosmo
 Cosmo, Brotkorb rechteckig mit Rollhaube
 Cesta pan rectangular con tapa roll-top Cosmo

Acciaio Verniciato - Varnished Steel / Juta / SAN

	cm	H. cm	in	H. in
V333224011	36x21	28	14,1/8x8,1/4	11



Forbici servire pasticceria Lux

Lux pastry serving scissors
 Ciseaux à servir gâteau Lux
 Tijeras para servir pastelería Lux
 Lux Gebäck-Servierzange

Acciaio Inox 18/10 - St. Steel 18/10

	mm	in
9030581FPS	210	8,1/4



Forbici servire pane Lux

Lux bread serving scissors tongs
 Pince ciseaux à servir pain Lux
 Pinzas tijeras para servir pan Brot Lux
 Lux Servierzange

Acciaio Inox 18/10 - St. Steel 18/10

	mm	in
9030581FPA	250	8,7/8





Caratteristiche tecniche

- A** Asportabilità del coperchio a 90° con estrema facilità.
- B** Coperchio leggero e facilmente maneggiabile.
- C** Blocco automatico dell'estrazione del coperchio in fase di lavoro (da 0° a 89°).
- D** Chiusura e apertura frenata del coperchio. Sistema di cerniere brevettate Abert
- E** Il coperchio si ferma, quando è lasciato, in qualsiasi posizione da 0° a 70°.
- F** Superati i 70° il coperchio si apre completamente lasciandolo andare.
- G** La cerniera è un meccanismo a molla, inalterabile nel tempo, non necessita di regolazione e di manutenzione in quanto non ha frizione.
- H** Tutti i meccanismi sono costruiti in pregiati materiali inossidabili, quindi resistenti alla corrosione, agli ambienti umidi e adatti al contatto con gli alimenti.
- I** Lo scaldavivande è progettato per raccogliere la condensa in modo da lasciare il piano di appoggio completamente asciutto.
- L** Può essere utilizzato sia con riscaldamento elettrico sia con fornelli a combustibile solido.

Technical characteristics

- A** Easily removable cover, at 90°.
- B** Light and easy-to-handle cover.
- C** Automatic block of cover pull out when in operation (from 0° to 89°).
- D** closing and opening slowed by cover. Abert patented system.
- E** The cover stops, when released, in any position from 0° to 70°.
- F** Over 70° the cover opens fully when released.
- G** The hinge is a spring mechanism, inalterable in time, it does not need regulation and maintenance as it has no clutch.
- H** All the machineries are built in refined stainless materials, thus resistant to corrosion, humid environment and suitable for food contact.
- I** The chafing dish is designed to collect condensation, in order to keep the support base completely dry.
- L** Both electric warming and solid-fuelburners can be used.

Fornelletto per scaldavivande

Chafing-dish burner

Porte-brûleur pour chafing dish

Brennstoffhalter für Chafing Dish

Contenedor de combustible para chafing dish

V77 05 52 FDC
Incluso - Included



Piastra elettrica

Electric hot plate

Plaque électrique

Elektrische Platte

Placa eléctrica

Con regolatore - With regulator

V770552PCT2

Non incluso - Not included

Piastra elettrica con regolatore per
scaldavivande 2/3 V230

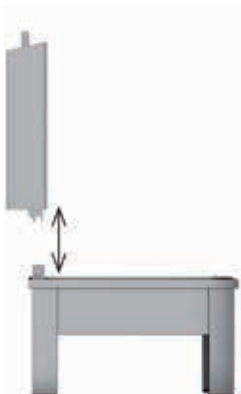

SISTEMA DI CERNIERE BREVETTATO
PATENTED SYSTEM



Scaldavivande Cosmo GN 2/3 con telaio acciaio

Cosmo chafing-dish, GN 2/3 with steel support
Chafing dish Cosmo GN 2/3 avec support en acier
Chafing dish Cosmo GN 2/3 con soporte en acero
Cosmo, Chafing dish, GN 2/3 mit Stahlauflage

Acciaio Inox 18/10 - St. Steel 18/10

V330552001



Scaldavivande Cosmo GN 2/3 per induzione con telaio acciaio

Cosmo chafing-dish, GN 2/3, induction with steel support
Chafing dish Cosmo GN 2/3 induction avec support en acier
Chafing dish Cosmo GN 2/3 inducción con soporte en acero
Cosmo, Chafing dish, Induktion, GN 2/3 mit Stahlauflage

Acciaio Inox 18/10 - St. Steel 18/10

V330552007



Scaldavivande Cosmo GN 2/3 con telaio nero

Cosmo chafing-dish, GN 2/3 with black support
 Chafing dish Cosmo GN 2/3 avec support noir
 Chafing dish Cosmo GN 2/3 con soporte negro
 Cosmo, Chafing dish, GN 2/3 mit schwarzer Auflage

Acciaio Inox 18/10 - St. Steel 18/10

V331852001

**Scaldavivande Cosmo GN 2/3 per induzione con telaio nero**

Cosmo chafing-dish, GN 2/3, induction, with steel support
 Chafing dish Cosmo GN 2/3 induction avec support noir
 Chafing dish Cosmo GN 2/3 inducción con soporte negro
 Cosmo, Chafing dish, Induktion, GN 2/3 mit schwarzer Auflage

Acciaio Inox 18/10 - St. Steel 18/10

V331852007



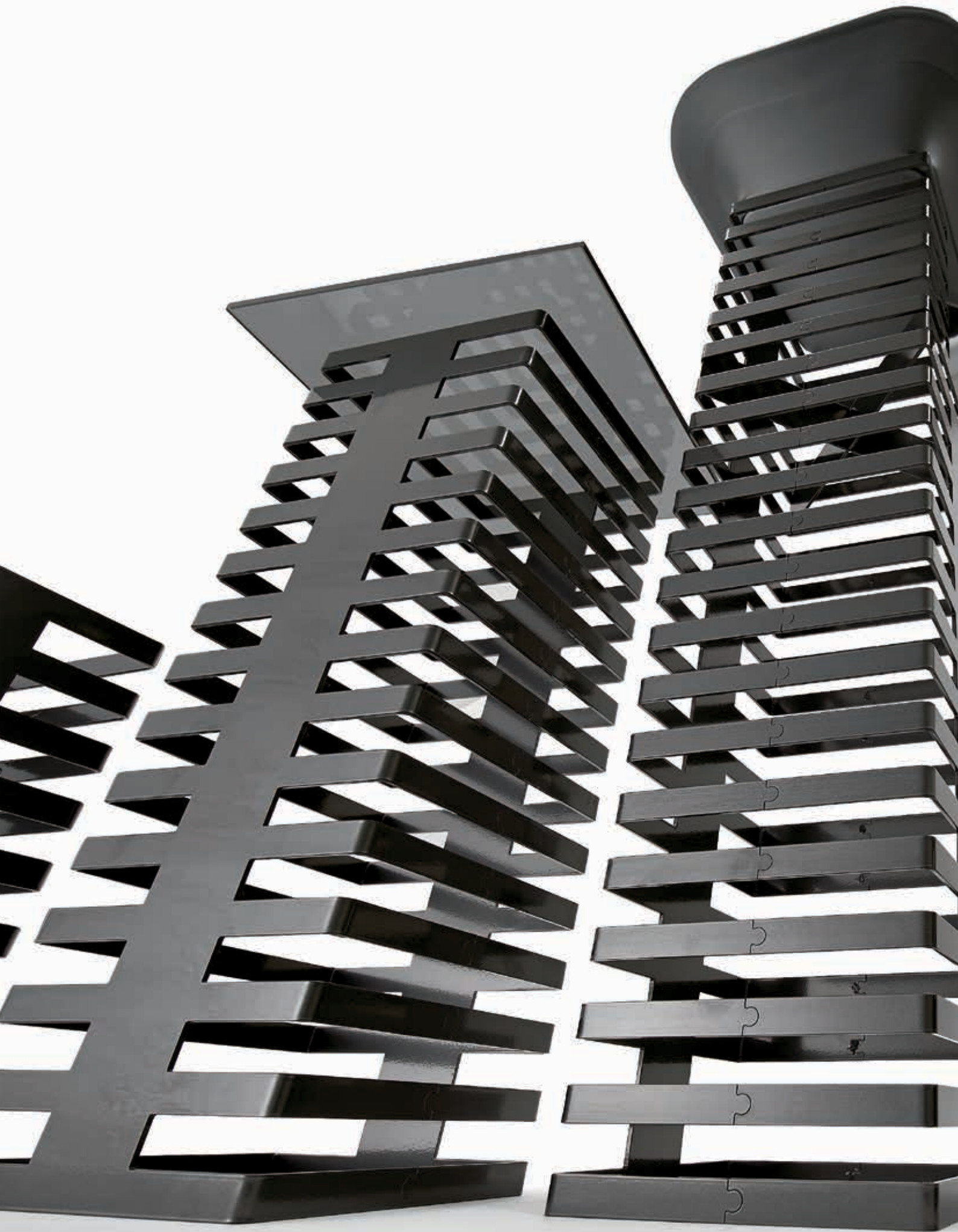

Urban

Abert firma Urban, un supporto creativo per le preparazioni in sala, versatile, fantasioso e bello da vedere.

Base ideale per un buffet di finger food, impeccabile supporto da colazione grazie ai numerosi accessori correlati e perfetto allestimento emozionale per aperitivi e brunch.

Urban è facile da allestire e consente la veloce creazione di figure geometriche modulari sempre diverse, per posizionare ogni creazione culinaria secondo la propria fantasia.

Abert has designed Urban, a creative support for food preparation in the restaurants, versatile, multipurpose and nice to see.

Ideal base for a finger-food buffet, perfect lunch podium system thanks to the numerous accessories provided, and impressive set-up for the happy hour and the brunch.

Urban is easy to assemble and allows the fast creation of continuously different modular shapes, in order to place every food preparation according to everyone's imagination.

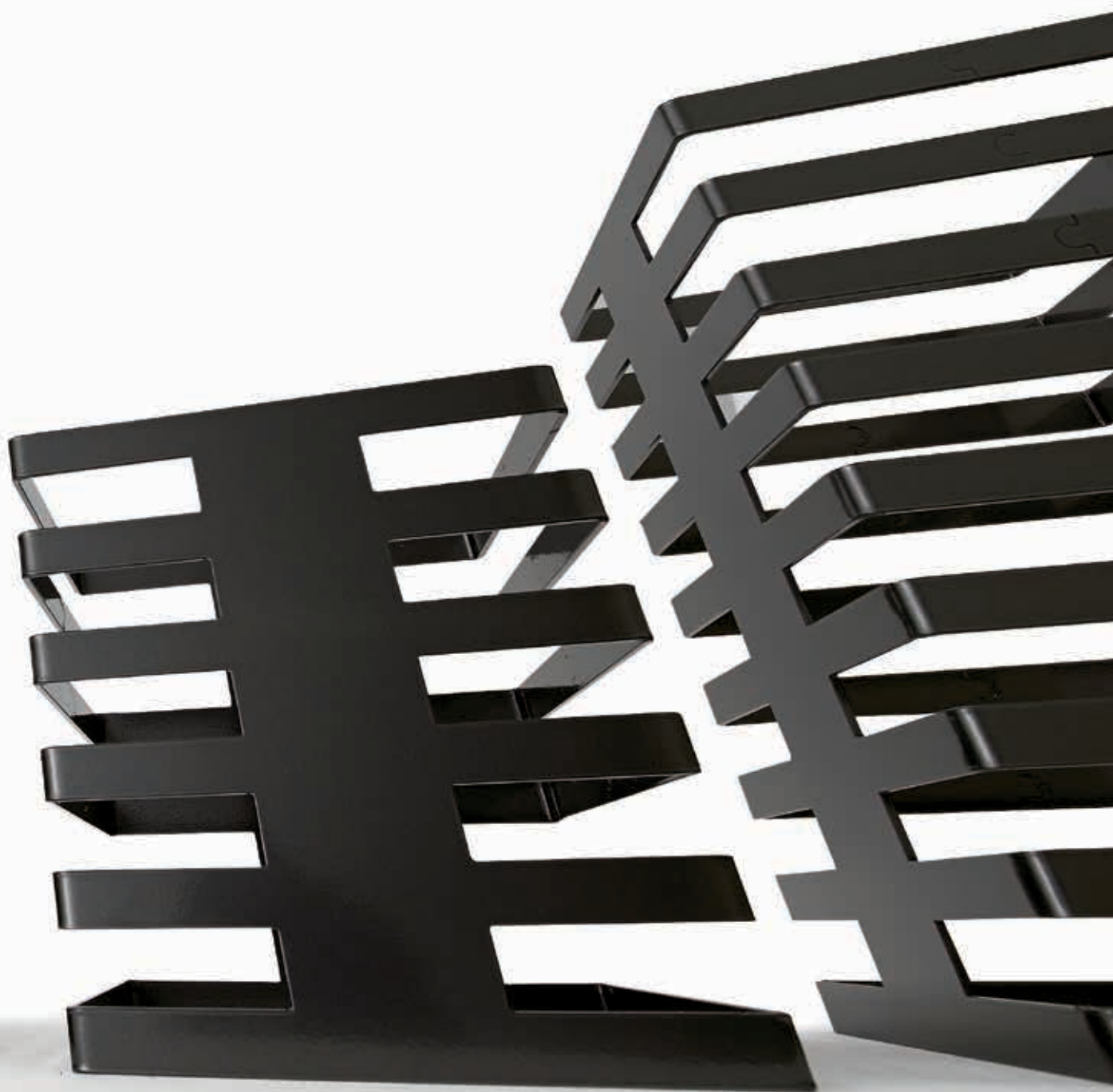



SET 1

Urban Tower
Tower Urban
Tower Urban
Urban Tower

V87 32 42 001	cm	H. cm
	140x42	67
	in	H. in
	55,1/8x16,1/2	26,3/8



SET 4

Urban Tower
Tower Urban
Tower Urban
Urban Tower

V87 32 42 004	cm	H. cm
	260x42	67
	in	H. in
	102,1/8x16,1/2	26,3/8





SET 3

Urban Tower
Tower Urban
Tower Urban
Urban Tower

V87 32 42 003

cm	H. cm
150x145	67
in	H. in
59,1/8x57,1/8	26,3/8

SET 2

Urban Tower
Tower Urban
Tower Urban
Urban Tower

V87 32 42 002

cm	H. cm
140x42	43
in	H. in
55,1/8x16,1/2	17



Tower

	cm	H. cm	in	H. in
V87 18 42 001	20x20	10	7,7/8x7,7/8	4
V87 18 42 002	20x20	22	7,7/8x7,7/8	8,5/8
V87 18 42 003	20x20	34	7,7/8x7,7/8	13,3/8
V87 18 42 004	20x20	58	7,7/8x7,7/8	22,7/8



Modulo a croce

Cross-shaped extension unit
 Croix
 Verbindungskreuz
 Módulo con forma de cruz

	H. cm	in
V87 18 42 CRO	9,5	3,3/4

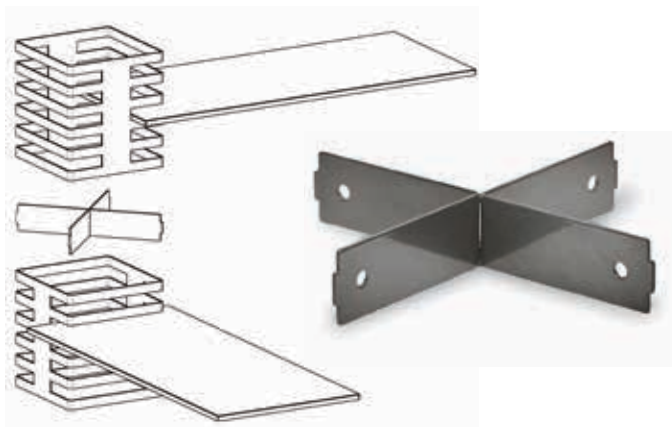

Coppa quadrata in plexiglass fumé

Smoky plexiglass salad bowl, square

Bol plexiglass fumé carrén

Salatschale Plexiglas viereckig Smoky

Ensaladera acrílica fumé cuadrada

	cm	H. cm	in	H. in
V87 12 42 C01	34x34	11	13,3/8x13,3/8	4,3/8

**Piano in vetro fumé**

Smoky glass top

Dessus en verre fumé

Glasplatte Smoky

Tablero de cristal fumé

	cm	in
V87 08 42 Q01	30x30	11,3/4x11,3/4
V87 08 42 Q02	42x42	16,1/2x16,1/2
V87 08 42 R01	30x70	11,3/4x27,1/2
V87 08 42 R02	30x100	11,3/4x39,3/8
V87 08 42 R03	42x70	16,1/2x27,1/2
V87 08 42 R04	42x100	16,1/2x39,3/8

**Piano in ardesia**

Slate top

Dessus en ardoise

Schieferplatte

Tablero de pizarra

	cm	in
V87 09 42 Q01	30x30	11,3/4x11,3/4
V87 09 42 Q02	42x42	16,1/2x16,1/2
V87 09 42 R01	30x70	11,3/4x27,1/2
V87 09 42 R02	30x100	11,3/4x39,3/8
V87 09 42 R03	42x70	16,1/2x27,1/2
V87 09 42 R04	42x100	16,1/2x39,3/8

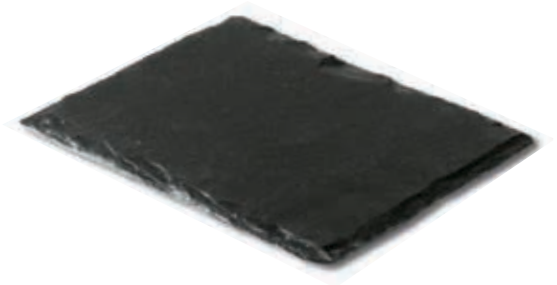
**Piano in mdf**

Mdf top

Dessus en mdf

Mdf Platte

Tablero de mdf

	cm	in
V87 04 42 Q01	30x30	11,3/4x11,3/4
V87 04 42 Q02	42x42	16,1/2x16,1/2
V87 04 42 R01	30x70	11,3/4x27,1/2
V87 04 42 R02	30x100	11,3/4x39,3/8
V87 04 42 R03	42x70	16,1/2x27,1/2
V87 04 42 R04	42x100	16,1/2x39,3/8

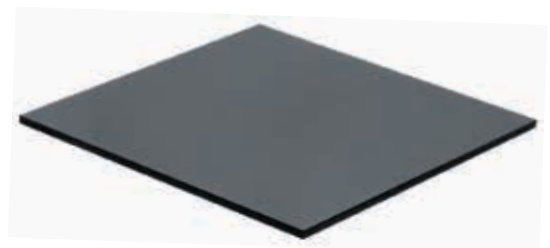

**Scaldavivande da incasso
con coperchio in acciaio Inox**

Built-in chafing dish with St. Steel cover
Chafing dish encastrable avec couvercle en acier Inox
Chafing Dish zum Einbauen mit Edelstahl Deckel
Chafing dish para empotrar con tapa en acero Inox

Acciaio Inox 18/10 - St. Steel 18/10

	GN	cm	H. cm
V87 18 52 002	1/1	60,5x40,5	39,5
		in	H. in
		23,7/8x16	15,1/2

2 fornelletti - 2 burners



Completo di due fornelli a combustibile solido
e predisposto per piastra elettrica.
Portavivande in acciaio incluso

*With two solid fuel burners,
electric heating element available.
With Gastronorm food pan*



**Scaldavivande da incasso
con coperchio in acciaio Inox /vetro**

Built-in chafing dish with St. Steel / glass cover
Chafing dish encastrable avec couvercle en acier Inox / verre
Chafing Dish zum Einbauen mit Edelstahl / Glass Deckel
Chafing dish para empotrar con tapa en acero Inox / vidrio

Acciaio Inox 18/10 - St. Steel 18/10

	GN	cm	H. cm
V87 18 52 003	1/1	60,5x40,5	39,5
		in	H. in
		23,7/8x16	15,1/2

2 fornelletti - 2 burners

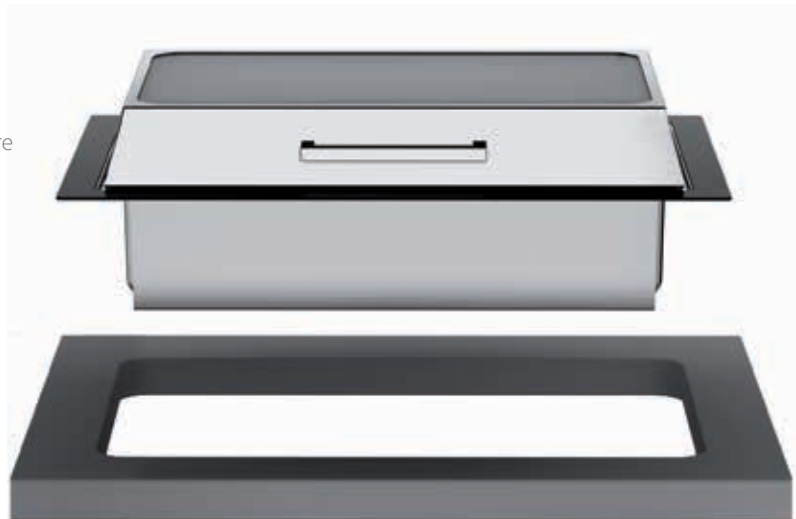

Completo di due fornelli a combustibile solido
e predisposto per piastra elettrica
Portavivande in acciaio incluso

*With two solid fuel burners,
electric heating element available.
With GN 1/1 Gastronorm food pan*



Scaldavivande con gambe e coperchio in acciaio Inox

Chafing dish with St. Steel stand and cover
Chafing dish avec support et couvercle en acier Inox
Chafing Dish mit Beinen und Edelstahldeckel
Chafing dish con soporte y tapa en acero Inox

Acciaio Inox 18/10 - St. Steel 18/10

	GN	cm	H. cm
V87 18 52 001	1/1	63x42	31
		in	H. in
		25,3/4x16,1/2	12,1/4

2 fornelli - 2 burners

	GN	cm	H. cm
V87 18 52 004	2/3	46x42	32
		in	H. in
		18,1/8x16,1/2	12,5/8

1 fornello - 1 burner

Completo di fornello a combustibile solido e predisposto per piastra elettrica.
Portavivande in acciaio incluso

*With solid fuel burners,
electric heating element available.
With Gastronorm food pan*



Scaldavivande con gambe e coperchio acciaio Inox/vetro

Chafing dish with St. Steel/glass stand and cover
Chafing dish avec support et couvercle en acier Inox / verre
Chafing Dish mit Beinen und Edelstahl / Glasdeckel
Chafing dish con soporte y tapa en acero Inox / vidrio

Acciaio Inox 18/10 - St. Steel 18/10

	GN	cm	H. cm
V87 18 52 005	1/1	63x42	33
		in	H. in
		25,3/4x16,1/2	12,1/4

2 fornelli - 2 burners

	GN	cm	H. cm
V87 18 52 006	2/3	46x42	32
		in	H. in
		18,1/8x16,1/2	12,5/8

1 fornello - 1 burner

Completo di fornello a combustibile solido e predisposto per piastra elettrica.
Portavivande in acciaio incluso

*With solid fuel burners,
electric heating element available.
With GN 1/1 Gastronorm food pan*

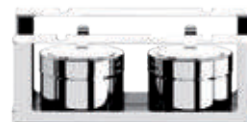

Inserto GN 1/1

GN 1/1 container
 Conteneur GN 1/1
 Gn - Behälter 1/1
 Contenedor GN 1/1

Acciaio Inox 18/10 - St. Steel 18/10

	cm	H. cm	Sp. mm
V01 05 72 G11	53x32,5	2	0,7
V01 05 72 G11 B	53x32,5	6,5	0,7

**Inserto GN 2/3**

GN 2/3 container
 Conteneur GN 2/3
 Gn - Behälter 2/3
 Contenedor GN 2/3

Acciaio Inox 18/10 - St. Steel 18/10

	cm	H. cm	Sp. mm
V01 05 72 G23	35,4x32,5	2	0,7
V01 05 72 G23 B	35,4x32,5	6,5	0,7

**Inserto GN 1/3**

GN 1/3 container
 Conteneur GN 1/3
 Gn - Behälter 1/3
 Contenedor GN 1/3

Acciaio Inox 18/10 - St. Steel 18/10

	cm	H. cm	Sp. mm
V01 05 72 G13	32,5x17,6	2	0,7
V01 05 72 G13 A	32,5x17,6	4	0,7

**Inserto GN 1/2**

GN 1/2 container
 Conteneur GN 1/2
 Gn - Behälter 1/2
 Contenedor GN 1/2

Acciaio Inox 18/10 - St. Steel 18/10

	cm	H. cm	Sp. mm
V01 05 72 G12	32,5x26,5	2	0,7
V01 05 72 G12 B	32,5x26,5	6,5	0,7

**Piastra elettrica**

Electric hot plate
 Plaque électrique
 Elektrische Platte
 Placa eléctrica

Con regolatore - With regulator

V770552PCR2 Piastra elettrica con regolatore per scaldavivande 1/1 V230

**Piastra elettrica**

Electric hot plate
 Plaque électrique
 Elektrische Platte
 Placa eléctrica

Con regolatore - With regulator

V770552PCT2 Piastra elettrica con regolatore per scaldavivande 2/3 V230



Inserto GN 1/1

Food pan, GN 1/1
 Conteneur GN 1/1
 Porzellanbehälter, GN 1/1
 Contenedor GN 1/1

Porcellana - Porcelain

	H. cm	H. in
V01 21 52 G11B	6,5	2,1/2
V01 21 52 G11	2	0,3/4

**Inserto GN 2/3**

Food pan, GN 2/3
 Conteneur GN 2/3
 Porzellanbehälter, GN 2/3
 Contenedor GN 2/3

Porcellana - Porcelain

	H. cm	H. in
V01 21 52 G23B	6,5	2,1/2

**Inserto GN 1/2**

Food pan, GN 1/2
 Conteneur GN 1/2
 Porzellanbehälter, GN 1/2
 Contenedor GN 1/2

Porcellana - Porcelain

	H. cm	H. in
V01 21 52 G12B	6,5	2,1/2

**Inserto GN 1/3**

Food pan, GN 1/3
 Conteneur GN 1/3
 Porzellanbehälter, GN 1/3
 Contenedor GN 1/3

Porcellana - Porcelain

	H. cm	H. in
V01 21 52 G13B	6,5	2,1/2



Urban Organizer

Un organizer flessibile e pratico che permette di risparmiare spazio sviluppandosi in verticale come un grattacielo urbano. Fornito dei suoi accessori contenitivi di acciaio e legno permette di allestire oggetti di diverse dimensioni e soddisfare ogni esigenza. Perfetto per Buffet, Hotel e Bar.





Tower

Tower
Tower
Tower
Tower

Ferro verniciato - Varnished Iron

	H. cm	H. in
V87 18 42 002	22	8,5/8
V87 18 42 003	34	13,3/8
V87 18 42 004	58	22,7/8



Contentitore Urban Organizer

Urban Organizer container
Conteneur Urban Organizer
Urban-Organizer Holzbehälter
Contenedor Urban Organizer

Legno - Wood

	cm	in
V87 04 42 CS1	10x10x8	4x4x3,1/8



Contentitore Urban Organizer

Urban Organizer container
Conteneur Urban Organizer
Urban-Organizer Holzbehälter
Contenedor Urban Organize

Legno - Wood

	cm	in
V87 04 42 CS2	15x10x4	6x4x1,1/2



Contentitore Urban Organizer

Urban Organizer container
Conteneur Urban Organizer
Urban-Organizer Holzbehälter
Contenedor Urban Organizer

Legno - Wood

	cm	in
V87 04 42 CS3	20x15x4	7,7/8x6x1,1/2
V87 04 42 CS4	20x15x8	7,7/8x6x3,1/8



Contentitore Urban Organizer

Urban Organizer container
Conteneur Urban Organizer
Urban-Organizer Holzbehälter
Contenedor Urban Organizer

Legno - Wood

	cm	in
V87 04 42 CS5	35x17,5x4	13,3/4x6,7/8x1,1/2
V87 04 42 CS6	35x17,5x8	13,3/4x6,7/8x3,1/8



Contentitore Urban Organizer

Urban Organizer container
Conteneur Urban Organizer
Urban-Organizer Edelstahlbehälter
Contenedor Urban Organizer

Acciaio Inox 18/10 - St. Steel 18/10

	cm	in
V87 05 42 CS1	6,5x10x4	2,1/2x4x1,1/2



Contenitore Urban Organizer

Urban Organizer container
 Conteneur Urban Organizer
 Urban-Organizer Edelstahlbehälter
 Contenedor Urban Organizer

Acciaio Inox 18/10 - St. Steel 18/10

	cm	in
V87 05 42 CS2	10x6,5x4	4x2,2/1x1,1/2

**Contenitore Urban Organizer**

Urban Organizer container
 Conteneur Urban Organizer
 Urban-Organizer Edelstahlbehälter
 Contenedor Urban Organizer

Acciaio Inox 18/10 - St. Steel 18/10

	cm	in
V87 05 42 CS3	18x4,5x4	7x1,3/4 x1,1/2

**Contenitore cilindrico per anello**

Cylindrical container for ring
 Conteneur cylindrique pour anneau
 Zylindrische Edelstahlbehälter für Ring
 Contenedor cilíndrico para anillo

Inox 18/10 - St. Steel

	ø cm	ø in	H. cm	H. in
V87 05 42 CS4	7,6	30	9,5	3,3/4

**Anello Urban Organizer**

Urban Organizer ring
 Anneau Urban organizer
 Edelstahlring für Urban-Organizer
 Anillo Urban Organizer

Acciaio Inox 18/10 - St. Steel 18/10

	ø cm	ø in
V87 05 42 A01	9	35,3/8

**Vassoio Urban Organizer**

Urban Organizer tray
 Plateau Urban Organizer
 Edelstahl Tablett für Urban Organizer
 Bandeja Urban Organizer

Acciaio Inox 18/10 - St. Steel 18/10

	cm	in
V87 05 42 V01	20x19	7,7/8x7,1/2

**Base per Tower Urban Organizer verniciata con perni**

Urban Organizer varnished, stand with pins
 Support Urban Organizer verni avec pivots
 Lackiert Gestell für Urban Tower, mit Zapfen
 Soporte Urban Organizer varnizado con pivotes

Ferro Verniciato - Varnished Iron

	cm	in
V87 05 42 B02	30x30	11,3/4x11,3/4

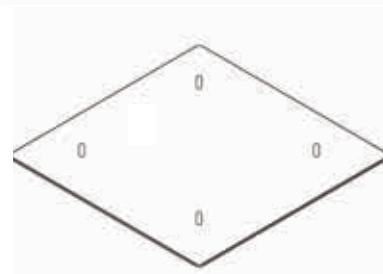





Mix&Play Revolution

Un'idea nuova ed originale nel concetto Buffet: **Mix&Play Revolution** consente con un tocco di creatività e fantasia di presentare cibi, bevande, stuzzichini ecc. ispirandosi ai diversi momenti di consumo (dalla colazione all'aperitivo) e alle tipologie dei locali. Un'opera d'arte che coniuga modernità e funzionalità in un prodotto che non ha eguali.

Le strutture in alluminio sono state pensate per soddisfare le differenti esigenze di spazio e di consumo del cliente. Sono l'esempio per eccellenza del concetto modulare consentendo la composizione di 5 differenti misure delle basi (2 quadrate e 3 rettangolari) per 3 differenti altezze. Con la creatività è possibile adattare **Mix&Play Revolution** Buffet al proprio spazio e creare sempre nuove ed originali presentazioni.

7 nuove composizioni studiate per facilitare la creazione del vostro buffet.

A new and original idea for the buffet: **Mix&Play Revolution** allows to present food and beverages etc. at different times of the day and different kinds of place, with an incredible touch of creativity and fantasy. A work of art that matches modern day practicality in just one product. The only one!

The metal podio are created to satisfy the different needs of space and consumption. They are easy excellent example of modular concept allowing the composition of 5 different sizes of base (2 square and 3 rectangular) for 3 different heights. By being creative it is possible to adapt **Mix&Play Revolution** Buffet to any kind of space and always provide new and fantastic Buffet.

7 new arrangements studied to make the preparation of your buffet easier.

Set 1

V86 32 42 003 Nero-Black
V86 32 42 010 Silver-Silver

cm	H. cm	in	H. in
52,5x70	24	20,5/8x27,1/2	9,1/2



Set 2

V86 32 42 004 Nero-Black
V86 32 42 011 Silver-Silver

cm	H. cm	in	H. in
35x70	24	13,3/4x27,1/2	9,1/2



Set 3

V86 32 42 005 Nero-Black
V86 32 42 012 Silver-Silver

cm	H. cm	in	H. in
52,5x70	22,5	20,5/8x27,1/2	8,7/8



Set 4

V86 32 42 006 Nero-Black
V86 32 42 013 Silver-Silver

cm	H. cm	in	H. in
52,5x70	22,5	20,5/8x27,1/2	8,7/8



Set 5

V86 32 42 007 Nero-Black
V86 32 42 014 Silver-Silver

cm	H. cm	in	H. in
52,5x70	16	20,5/8x27,1/2	6,1/4



Set 6

V86 32 42 008 Nero-Black
V86 32 42 015 Silver-Silver

cm	H. cm	in	H. in
52,5x52,5	16	20,5/8x20,5/8	6,1/4



Set 7

V86 32 42 009 Nero-Black
V86 32 42 016 Silver-Silver

cm	H. cm	in	H. in
52,5x52,5	16	20,5/8x20,5/8	6,1/4



Alzata modulare quadrata

Square modular podium
Etagère modulaire carrée
Modulständer, viereckig
Expositor modular cuadrado

	cm	H. cm	in	H. in
Argento - Silver				
V86 11 42 Q01	17,5x17,5	9,5	6,7/8x6,7/8	3,3/4
V86 11 42 Q02	17,5x17,5	16	6,7/8x6,7/8	6,1/4
V86 11 42 Q03	17,5x17,5	22,5	6,7/8x6,7/8	8,7/8
Nero - Black				
V86 15 42 Q01	17,5x17,5	9,5	6,7/8x6,7/8	3,3/4
V86 15 42 Q02	17,5x17,5	16	6,7/8x6,7/8	6,1/4
V86 15 42 Q03	17,5x17,5	22,5	6,7/8x6,7/8	8,7/8



Alzata modulare quadrata

Square modular podium
Etagère modulaire carrée
Modulständer, viereckig
Expositor modular cuadrado

	cm	H. cm	in	H. in
Argento - Silver				
V86 11 42 Q04	35x35	9,5	13,3/4x13,3/4	3,3/4
V86 11 42 Q05	35x35	16	13,3/4x13,3/4	6,1/4
V86 11 42 Q06	35x35	22,5	13,3/4x13,3/4	8,7/8
Nero - Black				
V86 15 42 Q04	35x35	9,5	13,3/4x13,3/4	3,3/4
V86 15 42 Q05	35x35	16	13,3/4x13,3/4	6,1/4
V86 15 42 Q06	35x35	22,5	13,3/4x13,3/4	8,7/8



Alzata modulare rettangolare

Rectangular modular podium
Etagère modulaire rectangulaire
Modulständer, rechteckig
Expositor modular rectangular

	cm	H. cm	in	H. in
Argento - Silver				
V86 11 42 R01	17,5x35	9,5	6,7/8x13,3/4	3,3/4
V86 11 42 R02	17,5x35	16	6,7/8x13,3/4	6,1/4
V86 11 42 R03	17,5x35	22,5	6,7/8x13,3/4	8,7/8
Nero - Black				
V86 15 42 R01	17,5x35	9,5	6,7/8x13,3/4	3,3/4
V86 15 42 R02	17,5x35	16	6,7/8x13,3/4	6,1/4
V86 15 42 R03	17,5x35	22,5	6,7/8x13,3/4	8,7/8



Alzata modulare rettangolare

Rectangular modular podium
Etagère modulaire rectangulaire
Modulständer, rechteckig
Expositor modular rectangular

	cm	H. cm	in	H. in
Argento - Silver				
V86 11 42 R04	17,5x52,5	9,5	6,7/8x20,5/8	3,3/4
V86 11 42 R05	17,5x52,5	16	6,7/8x20,5/8	6,1/4
V86 11 42 R06	17,5x52,5	22,5	6,7/8x20,5/8	8,7/8
Nero - Black				
V86 15 42 R04	17,5x52,5	9,5	6,7/8x20,5/8	3,3/4
V86 15 42 R05	17,5x52,5	16	6,7/8x20,5/8	6,1/4
V86 15 42 R06	17,5x52,5	22,5	6,7/8x20,5/8	8,7/8



Alzata modulare rettangolare

Rectangular modular podium
Etagère modulaire rectangulaire
Modulständer, rechteckig
Expositor modular rectangular

	cm	H. cm	in	H. in
Argento - Silver				
V86 11 42 R07	35x52,5	9,5	13,3/4x20,5/8	3,3/4
V86 11 42 R08	35x52,5	16	13,3/4x20,5/8	6,1/4
V86 11 42 R09	35x52,5	22,5	13,3/4x20,5/8	8,7/8
Nero - Black				
V86 15 42 R07	35x52,5	9,5	13,3/4x20,5/8	3,3/4
V86 15 42 R08	35x52,5	16	13,3/4x20,5/8	6,1/4
V86 15 42 R09	35x52,5	22,5	13,3/8x20,5/8	8,7/8



Piano legno quadrato

Square wooden base
Tablette en bois carrée
Holzplatte, viereckig
Tablero de madera cuadrado

	cm	H. cm	in	H. in
V86 04 42 PQ1	17,5x17,5	0,8	6,7/8x6,7/8	0,3/8



Piano legno rettangolare

Rectangular wooden base
Tablette en bois rectangulaire
Holzplatte, rechteckig
Tablero de madera rectangular

	cm	H. cm	in	H. in
V86 04 42 PR1	17,5x35	0,8	6,7/8x13,3/4	0,3/8



Supporto legno inclinato quadrato

Square modular podium
Etagère modulaire carrée
Holzgestell, viereckig, schräg gestellt
Expositor modular cuadrado

	cm	H. cm	in	H. in
V86 04 42 SQ1	35x35	7,5	13,3/4x13,3/4	3



Supporto legno inclinato rettangolare

Rectangular modular podium
Etagère modulaire rectangulaire
Holzgestell, viereckig, schräg gestellt
Expositor modular rectangular

	cm	H. cm	in	H. in
V86 04 42 SR1	35x52,5	7,5	17,3/4x20,5/8	3



Vassoio legno quadrato

Square wooden tray
Plateau en bois carrée
Holztablett, viereckig
Bandeja de madera cuadrado

	cm	H. cm	in	H. in
V86 04 42 VQ1	35x35	4	13,3/4x13,3/4	1,1/2
V86 04 42 VQ2	35x35	8	13,3/4x13,3/4	3,1/8



Vassoio legno rettangolare

Rectangular wooden tray
Plateau en bois rectangulaire
Holztablett, rechteckig
Bandeja de madera rectangular

	cm	H. cm	in	H. in
V86 04 42 VR1	17,5x35	4	6,7/8x13,3/4	1,1/2
V86 04 42 VR2	17,5x35	8	6,7/8x13,3/4	3,1/8



Vassoio legno rettangolare

Rectangular wooden tray
Plateau en bois rectangulaire
Holztablett, rechteckig
Bandeja de madera rectangular

	cm	H. cm	in	H. in
V86 04 42 VR3	17,5x52,5	4	6,7/8x20,5/8	1,1/2
V86 04 42 VR4	17,5x52,5	8	6,7/8x20,5/8	3,1/8



Vassoio legno rettangolare

Rectangular wooden tray
Plateau en bois rectangulaire
Holztablett, rechteckig
Bandeja de madera rectangular

	cm	H. cm	in	H. in
V86 04 42 VR5	35x52,5	4	13,3/4x20,5/8	1,1/2
V86 04 42 VR6	35x52,5	8	13,3/4x20,5/8	3,1/8



Piatto quadrato porcellana

Square porcelain platter
 Plat carré en porcelaine
 Porzellanteller, viereckig
 Plato cuadrado de porcellana

	cm	in
V86 21 42 PQP	17,5x17,5	6,7/8x6,7/8



Piatto quadrato porcellana

Square porcelain platter
 Plat carré en porcelaine
 Porzellanteller, viereckig
 Plato cuadrado de porcellana

	cm	in
V86 21 42 PQG	35x35	13,3/4x13,3/4



Piatto rettangolare porcellana

Rectangular porcelain platter
 Plat rectangulaire en porcelaine
 Porzellanteller, rechteckig
 Plato rectangular de por

	cm	in
V86 21 42 PRE	17,5x35	6,7/8x13,3/4



Teglia rettangolare in porcellana

Rectangular porcelain baker
 Plate a roti rectangular en porcelaine
 Porzellanbackform, rechteckig
 Fuente rectangular porcelana

	cm	in
V86 21 42 TRE	17,5x35	6,7/8x13,3/4



Teglia quadrata in porcellana

Square porcelain baker
 Plate a roti carré en porcelaine
 Porzellanbackform, viereckig
 Fuente cuadrada de porcelana

	cm	in
V86 21 42 TQU	35x35	13,3/4x13,3/4



Ciotola quadra porcellana

Porcelain bowl
Bol carré en porcelaine
Porzellanschale, viereckig
Bol cuadrado de porcellana

	cm	H. cm	in	H. in
V86 21 42 CQ14	14x14	8	5,1/2x5,1/2	3,1/8



Ciotola quadra porcellana

Porcelain bowl
Bol carré en porcelaine
Porzellanschale, viereckig
Bol cuadrado de porcellana

	cm	H. cm	in	H. in
V86 21 42 CQ7	7x7	3,5	2,3/4x2,3/4	1,3/8



Bicchieri vetro basso

Glass glass, small
Verre Ginco
Glass, klein
Vaso cristal bajo

	ø cm	H. cm	lt
V86 08 42 BBA	6	8	0,10
	ø in	H. in	oz
	2,3/8	3,1/8	3,5



Bicchieri vetro alto

Glass glass, tall
Verre en verre haut
Glass, hoch
Vaso cristal alto

	ø cm	H. cm	lt
V86 08 42 BAL	7	11	0,15
	ø in	H. in	oz
	2,3/4	4,3/8	5



Coppa in vetro

Glass bowl
Coupelle en verre
Glasschale
Bol de vidrio

	ø cm	H. cm	ø in	H. in
V86 08 42 C12	12	7	4,3/4	2,3/4



Set ABS

Set 1
Set 1
Set 1
Set 1

	cm	H. cm	in	H. in
V86 32 42 S06 Nero-Black	87x52,5	23	34,1/4x20,5/8	9
V86 32 42 S07 Silver-Silver	87x52,5	23	34,1/4x20,5/8	9



Piano in ABS nero quadrato liscio

Square plain black ABS base
Plat carré en abs noir
ABS Platte, schwarz viereckig und glatt
Base en ABS negra cuadrada lisa

	cm	in
V86 12 42 QLI 15	17,5x17,5	6,7/8x6,7/8

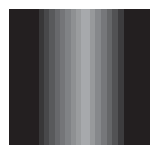

Piano in ABS nero rettangolare liscio

Rectangular plain black ABS base
Plat rectangulaire en ABS noir
ABS Platte, schwarz rechteckig und glatt
Base en ABS negra cuadrada lisa

	cm	in
V86 12 42 RLI 15	17,5x35	6,7/8x13,3/4



Piano abs nero quadrato 1 foro grande

Square Abs base with 1 hole
 Plat carré en abs noir 1 trou grand
 ABS Platte, schwarz mit einem Loch
 Base en ABS negra con 1 agujero grande

	cm	in
V86 12 42 Q1F 15	17,5x17,5	6,7/8x6,7/8



Piano abs nero rettangolare 2 fori grandi

Rectangular Abs base with 2 holes
 Plat rectangulaire en ABS noir 2 trous grands
 ABS Platte, schwarz rechteckig und mit 2 großen Löcher
 Base en ABS negra rectangular, con 2 agujeros grandes

	cm	in
V86 12 42 R2F 15	17,5x35	6,7/8x13,3/4

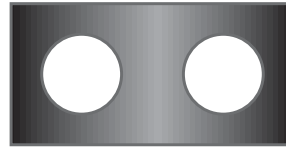

Piano abs nero quadrato 4 fori piccoli

Square Abs base with 4 holes
 Plat carré en ABS noir 4 trous petits
 ABS Platte, schwarz viereckig mit 4 kleinen Löcher
 Base en ABS negra cuadrada con 4 agujeros pequeños

	cm	in
V86 12 42 Q4F 15	17,5x17,5	6,7/8x6,7/8

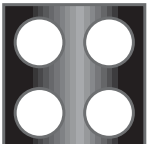

Piano abs nero rettangolare 8 fori piccoli

Rectangular Abs base with 8 holes
 Plat rectangulaire en ABS noir 8 trous petits
 ABS Platte, schwarz viereckig mit 8 kleinen Löcher
 Base en ABS negra rectangular, con 8 agujeros pequeños

	cm	in
V86 12 42 R8F 15	17,5x35	6,7/8x13,3/4

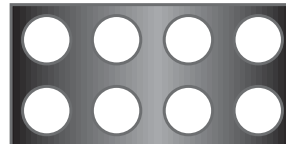

Protezione buffet chiusa

Buffet protection closed
 Protection buffet fermée
 Buffetschutz geschlossen
 Protección buffet cerrada

Plexiglass

	cm	in
V77 12 81 001	34x73xh51	13,3/8x28,3/4xh20,1/8

Protezione buffet aperta

Buffet protection open
 Protection buffet ouverte
 Buffetschutz offen
 Protección buffet abierta

Plexiglass

	cm	in
V77 12 81 002	34x73xh51	13,3/8x28,3/4xh20,1/8



Distributore succhi

Juice dispenser
 Distributeur jus
 Saftdispenser
 Dispensador de zumo

	lt	oz	cm	H. cm	in	H. in
V76 05 52 00 8R	3,5	118	20x31,5	51	7,3/4x12,1/2	20
V76 05 52 00 2R	7	237	27x37	56	10,5/8x14,1/2	22
V76 05 52 01 2R	12	405	27x37	51	10,5/8x14,1/2	20



Portaformaggi-affettati rettangolare refrigerato

Thermal rectangular cheese dish
 Plateau fromage - charcuterie rectangulaire réfrigérant
 Rechteckige Aufschnittplatte, gekühlt
 Quesera rectangular refrigerante

	cm	H. cm	in	H. in
V76 05 54 R0 1R	50x30	20	19,3/4x11,3/4	7,7/8





Distributore caffè

Coffee urn
Distributeur de café
Kaffeedispenser
Dispensador de café

	lt	cm	Hcm
V76 05 52 00 1R	10	26x33	64
	oz	in	H. in
	350	10,1/4x13	25,1/8



Distributore cereali singolo

Cereal dispenser
Distributeur céréales
Müeslidispenser
Dispensador de cereales

	lt	cm	Hcm
V76 05 52 01 0R	4	19,5x29	56
	oz	in	
	135	7,3/4x11,3/8	22

	lt	cm	Hcm
V76 05 52 01 1R	7	19,5x29	70
	oz	in	
	237	7,3/4x11,3/8	27,7/8

Buffet Square





Portaformaggi-affettati rettangolare refrigerato Square

Thermal rectangular cheese dish Square
 Plateau fromage-charcuterie rectangulaire réfrigérant Square
 Rechteckige Aufschnittplatte, gekühlt, Square
 Quesera rectangular refrigerante Square

Acciaio Inox 18/10 - St. Steel 18/10

	cm	H. cm	in	H. in
V76 05 54 R01	50x30	20	19,5/8x11,7/8	7,7/8



Coperchio a bascula rettangolare trasparente

Transparent rectangular rolltop cover
 Cloche basculante rectangulaire transparente
 Rolltophaube-rechteckig
 Campana rectangular transparente

SAN

	cm	in
V76 12 15 R01	47x27	18,1/2x10,5/8

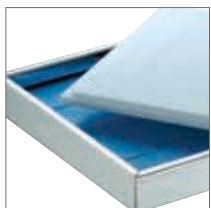

Tagliere rettangolare

Rectangular cutting board
 Planche à découper rectangulaire
 Rechteckiges Schneidebrett
 Tabla de cortar rectangular

Polietilene

	cm	in
V77 12 71 R01	47x27	18,1/2x10,5/8



4 Eutettici rettangolari

4 Ice packs
 4 Blocs réfrigérants
 4 Kühlakkus
 4 Acumuladores de frío rectangulares

1 eutettico/ 1 ice pack

V77 12 95 M00



Alzata filo per basi rettangolari

Square wire stand for rectangular bases
 Support en fil pour bases rectangulaires
 Drahtständer für rechteckigen Sockel
 Soporte filo de acero para bases rectangulares

Acciaio Inox 18/10 - St. Steel 18/10

	cm	H. cm
V76 05 42 001	50x30	27,5

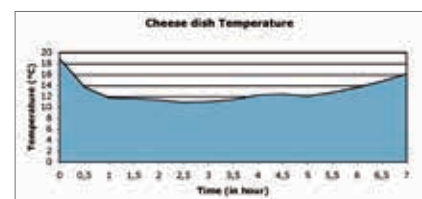

Temperatura ambiente External temperature 19,6°

Temperatura acqua Water temperature 18,9°

Mezzo refrigerante Cooler system 8 eutettici ghiaccio piccoli 8 small ice packs

Portaformaggi-affettati tondo refrigerato Square

Thermal round cheese dish Square

Plateau fromage-charcuterie rond réfrigérant Square

Runde Aufschnittplatte, gekühlt, Square

Quesera redonda refrigerante Square

Acciaio Inox 18/10 - St. Steel 18/10

	cm	H. cm	in	H. in
V76 05 54 T01	38x38	23	14,8/8x14,8/8	9



Coperchio a bascula tondo trasparente

Transparent round rolltop cover

Cloche basculante ronde transparente

Rolltophaube - rund

Campana redonda transparente

SAN

	ø cm	ø in
V76 12 15 T01	34	13,3/8



Tagliere quadrato con scanal. tonda

Square cutting board with round groove

Planche à découper carrée avec rainure ronde

Viereckiges Schneidebrett mit runder Rille

Tabla de cortar cuadrada con ranura

Polietilene

	cm	in
V77 12 71 T01	35x35	13,3/4x13,3/4



Eutettici rettangolari

Ice packs

Blocs réfrigérants

Kühlakkus

Acumuladores de frío rectangulares

1 eutettico/ 1 ice pack

V77 12 95 M00

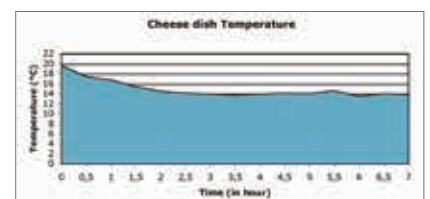

Temperatura ambiente External temperature 20,9°

Temperatura acqua Water temperature 19,5°

Mezzo refrigerante Cooler system 4 eutettici ghiaccio piccoli
4 small ice packs



Distributore succhi Square

Square juice dispenser

Distributeur jus Square

Saftdispenser Square

Dispensador de zumo Square

Acciaio Inox 18/10 - St. Steel 18/10

	cm	H. cm	lt	oz
V76 05 52 008	18x27,5	46	3,5	118
V76 05 52 002	24x31	50	7	237
V76 05 52 012	24x31	70	12	405

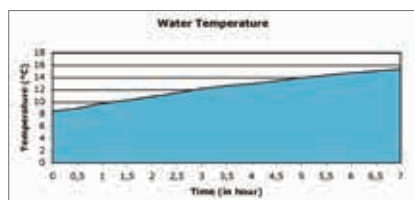

Temperatura ambiente
External temperature

20,0°

Temperatura acqua
Water temperature

7,6°

Quantità acqua inserita
Quantity of water added

7 lt

Distributore caffè Square

Coffee urn 10 lt
 Distributeur de café 10 lt
 Kaffeedispenser 10 lt
 Dispensador de café 10 lt

Acciaio Inox 18/10 - St. Steel 18/10

	cm	H. cm	lt	oz
V76 05 52 001	24x31	61	10	350



Fornelletto per scaldavivande / distributore caffè

Burner for chafing dish/coffee urn
 Porte bruleur pour chafing dish et distributeur café
 Brennstoffhalter für Chafing Dish und Kaffeedispenser
 Contenedor de combustible para chafing dish - dispensador de café

V77 05 52 FDC



Piastra elettrica per distributore caffè

Heating element for coffee urn
 Plaque électrique pour distributeur de café
 Elektro-Heizelement für Kaffeedispenser
 Plancha eléctrica para dispensador de café

V77 05 52 PDC Ø cm Ø in
 14 5,1/2

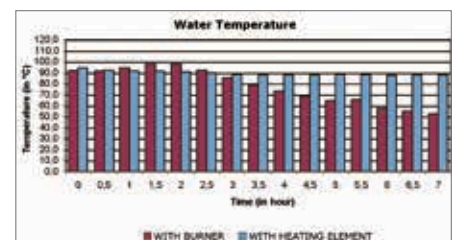

Temperatura ambiente 20,0°
 External temperature

Temperatura acqua 92,5°/98,8°
 Water temperature

Quantità acqua inserita 8 lt
 Quantity of water added

Distributore cereali singolo Square

Square cereal dispenser
Distributeur céréales Square
Mueslidispenser Square
Dispensador de cereales Square

Acciaio Inox 18/10 - St. Steel 18/10

	cm	H. cm	lt	oz
V76 05 52 010	18x27	53	4	135
V76 05 52 011	18x27	68	7	237

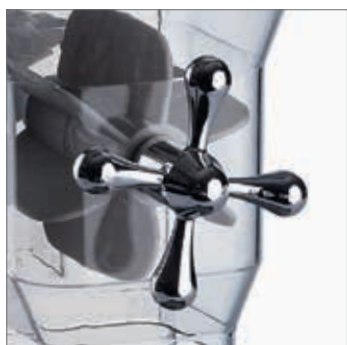

Tagliere per pane base acciaio Square

Square bread cutting board with St. Steel base
 Planche à découper à pain Square avec base en acier Inoxidable
 Brotschneidebrett Square mit Stahlgestell
 Tabla de cortar pan Square con base de acero Inoxidable

Acciaio Inox 18/10 - St. Steel 18/10

	cm	in
V76 05 54 001	50x30	19,5/8x11,7/8

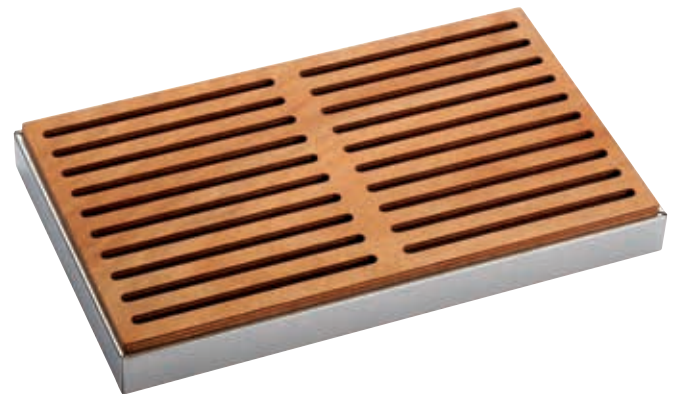
**Cestino pane acciaio per buffet Square**

Square bread basket for buffet, St. Steel
 Corbeille à pain en acier pour buffet Square
 Brotkorb Square für Buffet, Edelstahl
 Cesta pan en acero para buffet Square

Acciaio Inox 18/10 - St. Steel 18/10

	cm	in
V76 05 24 001	50x30	19,5/8x11,7/8

**Scaldabrioche Square con termostato**

Square croissant warmer
 Chauffe - croissants Square
 Croissantwärmer Square
 Calentador croissants Square

Acciaio Inox 18/10 - St. Steel 18/10

	cm	in
V76 05 52 020	47,5x28	18,3/4x11



Portamacedonia Square

Square yogurt/fruit-salad holder without lid
 Porte-salade de fruits/yogourt sans couvercle Square
 Joghurt/Obstsalatbehälter ohne Deckel Square
 Porta yogur/ensalada de frutas refrigerado sin tapa Square

Acciaio Inox 18/10 - St. Steel 18/10

	cm	in
V76 05 52 017	24x24	6,7/8x6,7/8

Con coperchio - with lid

V76 05 52 007	24x24	6,7/8x6,7/8
---------------	-------	-------------

Senza coperchio - without lid



Coperchio metacrilato c/pomolo Square

Acrylic lid with knob Square
 Couvercle acrylique avec pommeau Square
 Deckel aus Acryl mit wwquare
 Tapa acrílica con perilla Square

	ø cm	ø in
310 12 15 797	23	9



Ciotola in vetro

Glass bowl
 Bol en verre
 Glasschale
 Bol de vidrio

	ø cm	ø in
310 08 42 527	23	9



Disco copri eutettici

Ice pack cover
 Disc pour blocs réfrigérants
 Disco para acumuladores de frío
 Kühlakkus Scheibe

	ø cm	ø in
Z76 60 52 007	24	9,1/2



3 Eutettici rettangolari

3 Ice packs
 3 Blocs réfrigérants
 3 Kühlakkus
 3 Acumuladores de frío rectangulares

1 eutettico/ 1 ice pack

V77 12 95 M00



Contenitore in metallo porta macedonia /eutettico Square

Square metal fruit salad holder 24x24 cm w/o ice pack
 Conteneur en métal pour salade de fruits sans bloc réfrigérant Square
 Metalbehälter ohne Kühlakkus Square
 Porta ensalada de frutas en metal Square sin acumuladore de frío

	cm	in
Z76 20 52 007	24x24	6,7/8x6,7/8



Portayogurt/marmellata refrigerato Square

Square thermal yogurt/jam holder for pitcher

Rafrâichisseur yaourt/confiture Square

Joghurt/Marmeladebehälter, gekühlt Square

Portayogurt/mermelada refrigerado Square

Acciaio Inox 18/10 - St. Steel 18/10

	cm	H. cm	in	H. in
V76 05 52 014	17,5x17,5	7	6,7/8x6,7	3,3/4
Con coperchio - with lid				

V76 05 52 004	17,5x17,5	7	6,7/8x6,7	3,3/4
Senza coperchio - without lid				

Coperchio porta yogurt c/pomolo Square

Square lid with knob for yogurt holder

Couvercle sans pomole pour porte-yaourt Square

Deckel für Joghurtbehälter Square

Tapa para portayogurt sin perilla Square

	ø cm	ø in
Z76 01 52 004	15	6

Ciotola in vetro

Glass bowl

Bol en verre

Glasschale

Bol en vidrio

	ø cm	ø in	lt	oz
V76 08 52 004	15	6	0,5	17

Disco copri eutettici

Ice pack cover

Disc pour blocs réfrigérants

Kühlakku Scheibe

Disco para acumuladores de frío

	ø cm	ø in
Z76 60 52 005	15	6

Eutettici tondi

Round ice packs

Blocs réfrigérants ronds

Abdeckungscheibe für Kühlakku

Acumuladores de frío rectangulares

	ø cm	ø in
V77 12 95 T01	14,5	5,3/4

Contentitore in metallo porta caraffe/yogurt s/eutettico Square

Square pitcher/yogurt holder w/out ice pack

Conteneur en métal pour carafes/yaourt sans bloc réfrigérant Square

Metalbehälter ohne Kühlakku Square

Portayogurt/jarra sin acumulador de frío Square

	cm	H. cm	in	H. in
Z76 20 52 004	17,5x17,5	7	6,7/8x6,7	3,3/4



Portacaraffa con coperchio refrigerato Square

Square thermal pitcher holder with lid
 Porte-carafe avec couvercle réfrigérante Square
 Karaffenträger mit Deckel, gekühlt Square
 Soporte refrigerado para jarra con tapa Square

Acciaio Inox 18/10 - St. Steel 18/10

	lt	oz
V76 05 52 005	1,5	50

Con coperchio-with lid

V76 05 52 006	1,5	50
---------------	-----	----

Senza coperchio-without lid



Coperchio caraffa in acciaio per brocca

St. Steel lid for juice pitcher
 Couvercle en acier pour carafe
 Edelstahl Deckel für Karaffe
 Tapa en acero para jarra

	ø cm	ø in
--	------	------

Z76 01 52 005	10	4
---------------	----	---



Caraffa vetro

Glass pitcher
 Carafe en verre
 Saftkanne
 Jarra de zumo

	lt	oz
--	----	----

V76 08 52 009	1,5	50
---------------	-----	----

Senza coperchio-without lid

V76 08 52 005	1,5	50
---------------	-----	----

Con coperchio-with lid



Disco copri eutettici

Ice pack cover
 Disc pour blocs réfrigérants
 Kühlakkus Scheibe
 Disco para acumuladores de frío

	ø cm	ø in
--	------	------

Z76 60 52 005	15	6
---------------	----	---



Eutettici tondi

Round ice packs
 Blocs réfrigérants ronds
 Kühlakkus rund
 Acumuladores de frío rectangulares

	ø cm	ø in
--	------	------

V77 12 95 T01	14,5	5,3/4
---------------	------	-------



Contenitore in metallo porta caraffe/yogurt s/eutettico Square

Square pitcher/yogurt holder w/o ice pack
 Conteneur en métal pour carafes/yaourt sans bloc réfrigérant Square
 Metalbehälter ohne Kühlakkus Square
 Portayogurt/jarra sin acumulador de frío Square

	cm	H. cm	in	H. in
Z76 20 52 004	17,5x17,5	7,5	6,7/8x6,73	



Portacaraffe con sistema refrigerante

Thermal pitcher 4-pc set
 Rafrâchisseur à 4 carafes
 Thermo-Karaffenthaler 4 Stck.
 Enfriador para 4 jarras

Acciaio Inox 18/10 - St. Steel 18/10

	cm	H. cm	in	H. in
V76 05 52 021	24x24	7,5	9,1/2x9,1/2	3

Caraffe non incluse - Water jugs not included

**Caraffa acqua con coperchio basculante**

Water glass pitcher with smart lid
 Carafe en verre avec couvercle basculant
 Wasserkaraffe
 Jarra de vidrio con tapa basculante

Vetro - Glass

	lt	oz
● V76 08 52 007	1	35
● V76 08 52 007 35	1	35
● V76 08 52 007 07	1	35

**Rinfresca caraffe con sistema refrigerante**

Thermal pitcher
 Rafrâchisseur à carafes
 Thermo-Karaffenthaler
 Enfriador de botallas

Acciaio Inox 18/10 - St. Steel 18/10

	ø mm	H. cm	ø in	H. in
V76 055 20 23	135	5	5,3/8	2

con eutettico - with ice pack
 caraffa esclusa - without pitcher

Eutettico per rinfresca caraffe

Ice pack for thermal pitcher
 Bloc réfrigérant pour rafrâchisseur à carafes
 Kühlelemente für Thermo-Karaffenthaler
 Acumulador de frío para enfriador de botallas

Polietilene - Polyethylene

	ø mm	H. cm	ø in	H. in
V77 12 95 T02	75	2,5	3	1

**Corpo per porta caraffa**

Container for thermal pitcher
 Conteneur pour rafrâchisseur à carafes
 Behälter für Thermo-Karaffenthaler
 Contenedor para enfriador de botallas

Acciaio Inox 18/10 - St. Steel 18/10

	ø mm	H. cm	ø in	H. in
Z76 20 52 023	135	5	5,3/8	2





Jambee

Un oggetto **elegante e contemporaneo**, adatto a ogni tipo di buffet: grazie al design unico e innovativo.

I materiali usati sono di **alto livello qualitativo** - acciaio Inox 18/10 e metacrilato - e rendono il distributore un oggetto pregiato.

MADE IN ITALY

La **tecnologia semplice**, ma al tempo stesso funzionale, permette di erogare dosi da 8gr (0.28 oz) di prodotto, riducendo gli sprechi ed eliminando le monoporzioni da 25gr (0.88 oz).

Questo consente un risparmio di prodotto e la riduzione dei rifiuti

nel rispetto dell'ambiente. inoltre è ideale per servire miele e marmellate di produzione artigianale, per fornire un prodotto di alto livello e che soddisfi anche i clienti più esigenti.

Un ottimo modo per arricchire l'esperienza della colazione, mantenendo **ordinato e pulito** il buffet.

Utilizzabile con prodotti erogabili semisolidi, come confetture, marmellate - pure con piccoli frammenti di frutta - e creme, ma anche con miele, sciroppi e salse di analoga consistenza.

Jambee è l'ideale per **ogni struttura ricettiva**: alberghi, pasticcerie, bar e ristoranti.



An **elegant and modern** object for all buffets, thanks to its unique and innovative design.

The materials used are **high quality** – 18/10 stainless steel and methacrylate – which makes the dispenser a fine object.

MADE IN ITALY

Its **simple technology**, though functional, allows to dispense 8 gr (0.28 oz) product doses, to reduce waste and get rid of 25 gr (0.88 oz) single dose jars.

That allows, as well, to save on product and reduce waste, respecting the environment.

Moreover, it is the ideal to dispense honey and homemade jams, in order to supply for a high-end product, capable of meeting even the most demanding customers' needs.

The best way to make the most of the breakfast experience, keeping the buffet **tidy and clean**.

It can be used with dispensable semisolid products like preserves, marmalades – even with small fruit pieces in them – , creams and honey, syrups and sauces as well, which have the same consistency.

Jambee is the ideal for **any accommodation facility**: hotels, pastry shops, bars and restaurants.

Jambee

Acciaio Inox 18/10 - St. Steel 18/10

	lt	oz	cm	in
V77 0552 DMB	0,7	24	12,5x34,5 H Min 44,5 H Max 58	5x13,5/8 H Min 17,1/2 H Max 22,7/8
V77 0552 DMC	1	35	12,5x34,5 H Min 48 H Max 71,5	5x13,5/8 H Min 18,3/4 H Max 28,1/8



Erogatore a siringa

Syringe nozzle
Embout seringue
AusgieBerspritze
Boquilla jeringa

Acciaio Inox 18/10 - St. Steel 18/10

Z77 4652 DMA



Erogatore standard

Standard nozzle
Embout standard
Standard AusgieBer
Boquilla estandar

Acciaio Inox 18/10 - St. Steel 18/10

Z77 4552 DMA

Pistone con coperchio

Piston with lid
Piston avec couvercle
Kolben mit Deckel
Pistón con tapa

**Acciaio Inox 18/10, Metacrilato e PP
St. Steel 18/10, Methacrylate and PP**

lt

Z77 9852 DMA 0,7
Z77 9852 DMA1 1

Contentitore

Container
Conteneur
Behälter
Contenedor

Metacrilato - Methacrylate

lt

Z77 2052 DMA 0,7
Z77 2052 DMA1 1

Targhetta porta etichetta

Label plate
Plaque porte-étiquette
Schild Etikettenhalter
Placa porta etiqueta

Metacrilato - Methacrylate**Z77 5752 DMA1****Porta coppette linea Jambee (adatta a contenere 50 coppette)**

Jambee bowl-holder with transparent bowls
Porte-bols avec bols transparents Jambee
Glasschalebehälter mit Glasschalen Jambee
Porta boles con boles transparentes Jambee

Acciaio Inox 18/10 - St. Steel 18/10

	ø cm	H. cm	ø in	H. in
V77 05 09 C01	15	26,5	5,9	10,3/8

Coppetta per marmellata

Jam bowl
Bol pour marmelade
Marmeladeschale
Bol para marmelada

Vetro - Glass

	ø cm	ø in
V77 08 09 001	6	2,3/8

Tappo

Cap
Capsule
Stöpsel
Tapón

Metacrilato - Methacrylate**Z77 1352 DMA****Contentitore completo**

Complete container
Conteneur complet
Komplett Behälter
Contenedor completo

Metacrilato - Methacrylate

lt

Z77 9952 DMA 0,7
Z77 9952 DMA1 1



Buffet Imperial





Portaformaggi/affettati rettangolare completo refrigerato con base in acciaio

Thermal rectangular cheese dish
 Plateau fromage-charcuterie rectangulaire réfrigéré
 Käse/Wurstwarenplatte - rechteckig
 Quesera rectangular refrigerante

Acciaio Inox - Polietilene
St.Steel - Polyethylene

	cm	H. cm	in	H. in
V77 05 54 G11 R	53x32,5	19	20,7/8x12,3/4	7,1/2



Coperchio a bascula rettangolare trasparente

Transparent rectangular rolltop cover
 Cloche basculante rectangulaire transparente
 Rolltophaube-rechteckig
 Campana rectangular transparente

	cm	in
V77 12 15 G11	47x27	18,1/2x10,5/8



Tagliere rettangolare

Rectangular cutting board
 Planche à découper rectangulaire
 Rechteckiges Schneidebrett
 Tabla de cortar rectangular

Polietilene - Polyethylene

	cm	in	Sp. mm	TH. in
V77 12 71 G11	47x27	18,1/2x10,5/8	1,5	0,5/8



Bacinella rettangolare

Rectangular pan
 Cuvette rectangulaire
 Schüssel - rechteckig
 Cubeta rectangular

Acciaio Inox 18/10 - St. Steel 18/10

	cm	H. cm	in	H. in
V77 05 14 G11	53x32,5	3,5	20,7/8x12,3/4	1,1/8



8 Eutettici rettangolari

8 Ice packs
 8 Blocs réfrigérants
 8 Kühlakkus
 8 Acumuladores de frío rectangulares

1 eutettico/ 1 ice pack

V77 12 95 M00

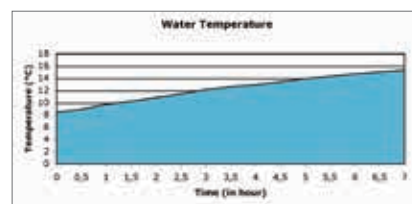

Temperatura ambiente
 External temperature 19,6°

Temperatura acqua
 Water temperature 18,9°

Mezzo refrigerante
 Cooler system 8 eutettici ghiaccio piccoli
 8 small ice pack

Portaformaggi/affettati tondo completo refrigerato con base in acciaio

Thermal round cheese dish

Plateau fromage-charcuterie rond réfrigéré

Käse/Wurstwarenplatte - rund

Quesera redonda refrigerante

Acciaio Inox - Polietilene**St. Steel - Polyethylene**

	cm	H. cm	in	H. in
V77 05 54 T46 R	46	27,5	18,1/8	10,7/8

**Coperchio a bascula tondo trasparente**

Transparent round rolltop cover

Cloche basculante ronde transparente

Rolltophaube - rund

Campana redonda transparente

	ø cm	ø in
V77 12 15 T46	41	16,1/8

**Tagliere tondo**

Round cutting board

Planche ronde

Schneidebrett - rund

Tabla para cortar redonda

Polietilene - Polyethylene

	ø cm	ø in	Sp. mm	TH. in
V77 12 71 T46	41	16,1/8	2	0,3/4

**Bacinella tonda**

Round pan

Cuvette ronde

Schüssel - rund

Cubeta redonda

Acciaio Inox 18/10 - St. Steel 18/10

	ø cm	H. cm	ø in	H. in
V77 05 14 T46	46	5	18,1/8	2

**4 Eutettici rettangolari**

4 Ice packs

4 Blocs réfrigérants

4 Kühlakkus

4 Acumuladores de frío rectangular

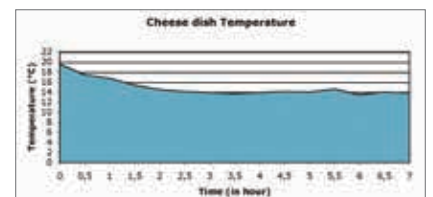
1 eutettico/ 1 ice pack**V77 12 95 M00**

Temperatura ambiente External temperature 20,9°

Temperatura acqua Water temperature 19,5°

Mezzo refrigerante Cooler system 4 eutettici ghiaccio piccoli
4 small ice pack

Portaformaggi/affettati rettangolare completo

Rectangular cheese dish
 Plateau fromage-charcuterie rectangulaire
 Käse/Wurstwarenplatte - rechteckig
 Quesera rectangular

	cm	H. cm	in	H. in
V77 05 54 G11	53x32,5	18	20,7/8x12,3/4	7



Portaformaggi/affettati tondo completo

Round cheese dish
 Plateau fromage-charcuterie rond
 Käse/Wurstwarenplatte - rund
 Quesera redonda

	ø cm	H. cm	ø in	H. in
V77 05 54 T46	46	24,5	18,1/8	9,5/8



Portayogurt

Yogurt tray
 Plateau porte-yogourt
 Joghurtplatte
 Bandeja yogur

Acciaio Inox 18/10 - St. Steel 18/10

	ø cm	ø in	H. cm	H. in
V77 05 52 T46	46	18,1/8	5	2



Portaburro/crostacei

Butter tray
 Plateau porte-beurre/crustacés
 Butter/Krustazeenplatte
 Bandeja mantequilla

Acciaio Inox 18/10 - St. Steel 18/10

	ø cm	ø in	H. cm	H. in
V77 05 09 T32	32	12,5/8	5	2
V77 05 09 T46	46	18,1/8	5	2



Rinfrescamacedonia/yogurt con contenitore ghiaccio esterno in acciaio con coperchio

Fruit-salad/yogurt cooler with outer ice container and lid
 Rafrâchisseur salade de fruits/yogourt avec récipient à glace externe avec couvercle
 Joghurt/Obstsalatbehälter mit Edelstahl - Eisbehälter außen mit Deckel
 Portaensalada de frutas/yogur refrigerado con recipiente para hielo externo con tapa

Acciaio Inox - St. Steel

	ø int. cm	ø int. in	ø est. cm	ø est. in
V77 05 43 YOG	23	9	28	11



Tagliere per pane con base acciaio

Bread cutting board
 Planche à découper à pain
 Tabla de cortar pan
 Brotschneidebrett

Acciaio Inox 18/10 - St. Steel 18/10

	cm	H. cm	in	H. in
V01 05 54 004	53x32,5	3,5	20,7/8x12,3/4	1,1/8



Imperial scaldavivande rettangolare con coperchio rotante inox

Imperial rectangular chafing dish
 Chafing dish rectangulaire Imperial
 Chafing dish rectangular Imperial
 Chafing Dish rechteckig Imperial

Acciaio Inox 18/10 - St. Steel 18/10

	GN	cm	H. cm	in	H. in
V77 05 52 CHR	1/1	65,5x48	44	25,3/4x19	17,3/8

Con:

Coperchio rotante a scomparsa
 Portavivande 1/1 Gastronorm
 2 bruciatori per pasta - combustibile
 Predisposto per piastra elettrica

With:

Rolltop
 1/1 gastronorm food pan
 2 solid fuel burners.
 Electric heating element
 (available as optional)



Fornelletto per scaldavivande

Chafing-dish burner
 Porte-brûleur pour chafing dish
 Brennstoffhalter für Chafing Dish
 Contenedor de combustible para chafing dish

V77 05 52 FDC



Piastra elettrica

Electric hot plate
 Plaque électrique
 Elektrische Platte
 Placa eléctrica

Con regolatore - With regulator

V770552PCR2 Piastra elettrica con regolatore per scaldavivande 1/1 V230

**Con fornelli
Whit burners**

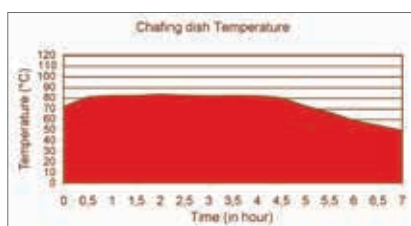

Temperatura ambiente External temperature	20,3°
Temperatura acqua Water temperature	94°
Quantità acqua inserita Quantity of water added	6 lt.
Fonte di calore Heat source	2 fornelli a fiamma 2 burners

**Con piastra elettrica
Whit heating element**

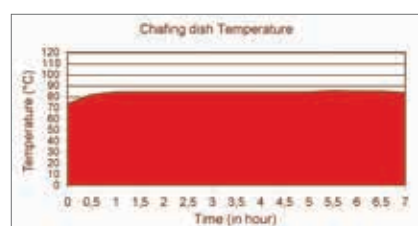

Temperatura ambiente External temperature	20,3°
Temperatura acqua Water temperature	94°
Quantità acqua inserita Quantity of water added	6 lt.
Fonte di calore Heat source	piastra elettrica heating element

Scaldavivande tondo con coperchio rotante

Round rolltop chafing dish

Chafing dish rond avec couvercle pivotant

Chafing Dish - rund mit Rolltophaube

Calientaplatos redondo con campana

Acciaio Inox 18/10 - St. Steel 18/10

	ø cm	H. cm	ø in	H. in
V77 05 52 CHT	50	46	15,3/4	18,1/8

Con:

Coperchio rotante a scomparsa

Portavivande ø 40 cm

1 bruciatore per pasta - combustibile

Predisposto per piastra elettrica

With:

Rolltop

Food pan ø 40 cm

Solid fuel burners.

Electric heating element

(available as optional)



Fornelletto per scaldavivande

Chafing-dish burner

Porte-brûleur pour chafing dish

Brennstoffhalter für Chafing Dish

Contenedor de combustible para chafing dish

V77 05 52 FDC



Piastra elettrica

Electric hot plate

Plaque électrique

Elektrische Platte

Placa eléctrica

Con regolatore - With regulator

V770552PCT2

Piastra elettrica con
regolatore per
scaldavivande 2/3 V230

Con fornelli

Whit burners

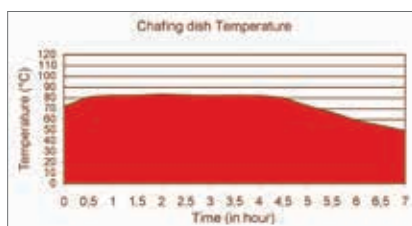

Temperatura ambiente External temperature	20,3°
Temperatura acqua Water temperature	94°
Quantità acqua inserita Quantity of water added	6 lt.
Fonte di calore Heat source	2 fornelli a fiamma 2 burners

Con piastra elettrica

Whit heating element

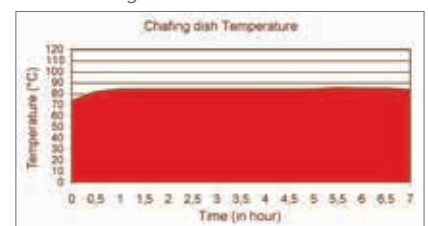

Temperatura ambiente External temperature	20,3°
Temperatura acqua Water temperature	94°
Quantità acqua inserita Quantity of water added	6 lt.
Fonte di calore Heat source	piastra elettrica heating element

Portavivande in porcellana

Food pan, porcelain
Bac en porcelaine
Porzellanbehälter
Cubeta de porcelana

	GN	cm	in
V01 21 52 G11B	1/1	53x32,5x6,5	20,7/8x12,3/4x2,1/2
V01 21 52 G23B	2/3	35,3x32,5x6,5	13,3/4x12,3/4x2,1/2
V01 21 52 G12B	1/2	26,5x32,5x6,5	10,3/8x12,3/4x2,1/2
V01 21 52 G13B	1/3	17,6x32,5x6,5	6,7/8x12,3/4x2,1/2



Portavivande tondo in porcellana

Round food pan, porcelain
Bac rond en porcelaine
Porzellanbehälter, rund
Cubeta redonda de porcelana

	ø cm	ø in
V01 21 52 T40	40	15,3/4



Inserto scaldavivande tondo in porcellana

Food pan half round chafing dish, porcelain with divider
Bac double en porcelaine pour chafing dish rond
Porzellaninsatz, 2tlg für Chafing Dish
Cubeta avec separation de porcelana para chafing dish redondo

	ø cm	ø in
V01 21 71 T12 (1 pz.)	40	15,3/4



Set zuppiere per scaldavivande tondo

Soup tureen set for cm. 40 round chafing dish
Set de soupières pour chafing dish rond
Suppenschüssel für Chafing Dish rund
Set de soperas para chafing dish redondo

Acciaio Inox 18/10 - St. Steel 18/10

	ø cm	ø in	lt	oz
V77 05 52 ACT	40	15,3/4	4,2	142



Set minstre per scaldavivande rettangolare

Soup tureen set for rectangular chafing dish
Set de soupières pour chafing dish rectangulaire
Suppenschüssel für Chafing Dish rechteckig
Set de soperas para chafing dish rectangular

Acciaio Inox 18/10 - St. Steel 18/10

	GN	lt	oz
V77 05 52 ACR	1/1	4,2	142



Porta cereali girevole a 3 comparti*

Triple rotating cereal holder

Distributeur céréales pivotant à 3 compartiments

Büffet-Ständer - drehbar mit 3 Glasschalen

Dipensador de cereales giratorio 3 sectores

Acciaio Inox 18/10 - St. Steel 18/10

	∅ cm	∅ in
V77 05 52 CER 3	42	16,1/2

**Porta cereali girevole a 6 comparti***

6-dish rotating cereal holder

Distributeur céréales pivotant à 6 compartiments

Büffet-Ständer - drehbar mit 6 Glasschalen

Dipensador de cereales giratorio 6 sectores

Acciaio Inox 18/10 - St. Steel 18/10

	∅ cm	∅ in
V77 05 52 CER	42	16,1/2 in



*Sono escluse le ciotole in vetro

*Without glass bowls

Ciotola in vetro

Glass bowl

Bol en verre

Glasschale

Bol de vidrio

	∅ cm	∅ in	lt	oz
310 08 42 527	23	9	1,3	60

**Coperchio in metacrilato**

Acrylic lid

Couvercle acrylique

Deckel aus Metakryl

Tapa acrílica

	∅ cm	∅ in
310 12 15 795	23	9

Con pomolo in metacrilato - With acrylic knob

310 12 15 790	23	9
---------------	----	---

Con pomolo in acciaio Inox - With St. Steel knob

Distributore cereali girevole a 3 comparti con base in acciaio

Triple rotating cereal dispenser with stainless steel base

Distributeur céréales pivotant à 3 compartiments avec base en acier Inoxidable

3-Müslidispenser-drehbar mit Stahlboden

Dispensador de cereales giratorio 3 sectores con base de acero Inoxidable

Acciaio Inox 18/10 - St. Steel 18/10

	ø cm	H. cm	ø in	H. in	lt	oz
V77 05 52 CD6	42	60	16,1/2	23,5/8	3 (x3)	101 (x3)

Con:

Contentore removibile

Pomolo in metallo

Spazzola interna

Girandola dosatrice

With:

Removable container

Metal knob

inner brush

Doser handle



Contentore removibile

Consente di riempirlo e pulirlo facilmente

Removable container

It allows to be filled in and cleaned easily



Spazzola interna

non rompe i cereali

inner brush

that does not break cereals



Dettaglio pomolo in metallo

Detail of metal knob



Girandola dosatrice

Doser handle



Distributore cereali a 2 compartimenti con base in acciaio

Double cereal dispenser with stainless steel base

Distributeur céréales à 2 compartiments avec base en acier Inoxidable

2-Müslidispenser mit Stahlboden

Dispensador de cereales 2 sectores con base de acero Inoxidable

Acciaio Inox 18/10 - St. Steel 18/10

	cm	H. cm	in	H. in	lt	oz
V77 05 52 CD5	37,5x24,5	60	14,3/4x9,5/8	23,5/8	3 (x2)	101 (x2)

**Distributore cereali singolo con base in acciaio**

Single cereal dispenser with stainless steel base

Distributeur céréales individuel avec base en acier Inoxidable

Müslidispenser mit Stahlboden

Dispensador de cereales individual con base de acero Inoxidable

Acciaio Inox 18/10 - St. Steel 18/10

	cm	H. cm	in	H. in	lt	oz
V77 05 52 CD4	31x21	60	12,1/4x8,1/4	23,5/8	3	101

**Cestino portabrioche tondo
con cloche basculante**

Round croissant basket with rolltop cover
Corbeille ronde à viennoiseries avec cloche basculante
Büffetkorb - rund mit Rolltophaube
Cesta de buffet redonda con campana roll top

Rattan - San

	ø cm	ø in	Hcm	H. in
V77 04 52 T44	44	17,3/8	35	13,3/4



**Cestino portabrioche rettangolare
con cloche basculante**

Rattan rectangular croissant basket with rolltop cover
Corbeille rectangulaire à viennoiseries avec cloche basculante
Büffetkorb - rechteckig mit Rolltophaube
Cesta de buffet rectangular con campana roll top

Rattan - San

	cm	in	H. cm	H. in
V77 04 52 R50	50x29,5	19,3/4x11,5/8	29,5	11,5/8



Supporto refrigerato per caraffe succhi con vassoio portabicchieri*

Thermal stand for juice pitchers with glasses tray*
Support réfrigéré pour carafes jus avec plateau porte-verres
Saftkaraffenständer gekühlt mit Gläserständer
Soporte refrigerante para jarras zumo con bandeja para vasos

Acciaio Inox 18/10 - St. Steel 18/10

	ø cm	ø in	H. cm	H. in
V77 05 52 SUC			67	26,3/8
Base	41,5	16,3/8		
Alzata - Holder	38,5	15,1/8		
Sede caraffa - Pitcher seat	16,4	6,1/2		

Supporto refrigerato per caraffe succhi*

Thermal stand for juice* pitchers
Support réfrigéré pour carafes jus
Saftkaraffenständer gekühlt
Soporte refrigerante para jarras zumo

Acciaio Inox 18/10 - St. Steel 18/10

	ø cm	ø in	H. cm	H. in
V77 05 52 SUS			36	14,1/8
Base	41,5	16,3/8		
Sede caraffa - Pitcher seat	16,4	6,1/2		



Disco coprieutettici per supporto refrigerante per caraffe

Plate for thermal stand for juice pitchers (to cover ice packs)
Plaque couvre-blocs réfrigérants pour support réfrigéré pour carafes
Deckel für Kühlelemente zum Karaffenbehälter
Placa cubre acumuladores de frío para soporte refrigerante para jarras

	ø cm	ø in
PRV 1A SU CAD S0	41	16,1/8

*Sono escluse le caraffe in vetro
*Without pitchers

Distributore caffè con rubinetto in metallo

Coffee urn
 Distributeur café
 Kaffeedispenser
 Dispensador de café

Acciaio Inox 18/10 - St. Steel 18/10

	ø cm	ø in	H. cm	H. in	lt	oz
V77 05 52 DCA	21	8,4	54	21,1/4	7	237
V77 05 52 DCA 1	21	8,4	62	24,3/8	10	350



Piastra elettrica per distributore caffè

Heating element for coffee urns
 Plaque électrique pour distributeur de café
 Elektro-Heizelement für Kaffeedispenser
 Plancha eléctrica para dispensadores de café

	ø cm	ø in
V77 05 52 PDC	14	5,1/2



Fornelletto per scaldavivande/distributore caffè

Burner for chafing dishes-coffee urns
 Porte bruleur pour chafing dish et distributeur café
 Brennstoffhalter für Chafing Dish und Kaffeedispenser
 Contenedor de combustible para chafing dish - dispensadores de café

V77 05 52 FDC

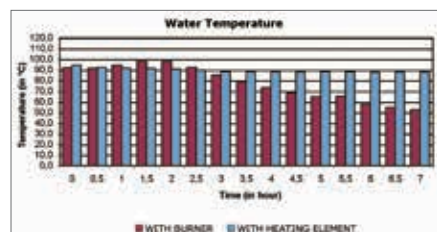

Temperatura ambiente
 External temperature

20,0°

Temperatura acqua
 Water temperature

92,5°/98,8°

Quantità acqua inserita
 Quantity of water added

8 lt

Distributore succhi

Juice dispenser

Distributeur jus

Saftdispenser

Dispensador de zumo

Acciaio Inox 18/10 - St. Steel 18/10

	cm	H	cm lt
V77 05 52 DSM	25x35	66	8
	in	H	in Oz
	9,7/8x13,3/4	26	270

**Contentore trasparente**

Transparent container

Récipient transparent

Durchsichtbare Behälter

Contenedor transparente

	lt	oz
Z77 63 52 000	8	270

**Eutettici tondi**

Round ice packs

Blocs réfrigérants

Kühlakkus

Acumuladores de frío rectangulares

V77 12 95 T01

Caraffa succhi

Juice pitcher
Carafe jus
Saftkanne
Jarra zumo

	lt	oz
V76 08 52 005	1,5	51

Con coperchio in metallo - with metal lid 18/10

V76 08 52 009	1,5	51
---------------	-----	----

Senza coperchio - without lid



Coperchio in acciaio 18/10

Stainless steel lid
Couvercle en acier 18/10
Deckel aus Edelstahl
Tapa de acero Inoxidable

Acciaio Inox 18/10 - St. Steel 18/10

Z76 01 52 005



Caraffa acqua con coperchio basculante

Water glass pitcher with smart lid
Carafe en verre avec couvercle basculant
Wasserkaraffe
Jarra de vidrio con tapa basculante

	lt	oz
● V76 08 52 007	1	35
● V76 08 52 007 35	1	35
● V76 08 52 007 07	1	35



Caraffa termica 18/10

Thermal beverage serve
Carafe thermos avec anse
Thermische Karaffe
Jarra térmica

Acciaio Inox 18/10 - St. Steel 18/10

	cl	oz
V01 05 08 T06	75	26
V01 05 08 T10	100	35
V01 05 08 T15	150	51
V01 05 08 T20	200	68



Cavalletto portaetichetta per buffet (senza tavoletta - without black tag)

Buffet easel for tags

Chevalet porte-nom pour buffet

Aufsteller Produktinfo

Soporte caballete para etiqueta para buffet

Inox 18/10 - St. Steel

	H. cm	H. in
V01 05 19 001	14,5	5,3/4



Tavoletta nera per cavalletto

Black tag for easel

Plaque pour chevalet noir

Schild für Produktinfo

Etiqueta negra para soporte caballete

Plexiglass

	H. cm	H. in
V01 12 19 001	10x7,5	4x3

Poggiamestolo

Ladle stand

Repose louche

Reposa cucharas

Ständer/Halter Soßenkelle

Inox 18/10 - St. Steel

	ø cm	ø in
V39 05 81 001	11	4,3/8



